



# stainless

## DOMESTIC SINK RANGE

Style and Functionality All-In-One



CLASSIQUE DESIGNER



CLASSIQUE PLUS



CLASSIQUE

# INDEX

---

CLASSIQUE RANGE	1
Sparta Series	2
Kiba Series	3
Laundry Series	4/5
CLASSIQUE PLUS RANGE	6
Athena Series	7
Amaltia Series	8
Hercules Series	9
CLASSIQUE DESIGNER RANGE	10
Crystalon Series	11
Olynthos Series	12
Lydia Series	13
Iris Series	14
OCTI PLUMBING KIT	15
STAINLESS STEEL CLEANING CRÈME	15

---

# CLASSIQUE RANGE

Sinks for the Discerning Home Owner



# SPARTA SERIES

Reversible Drop In Sinks

FEATURES: Austenitic Stainless Steel, Recessed Drainage Ledge, Folded Edges for Added Strength, 90mm Waste Fitting.

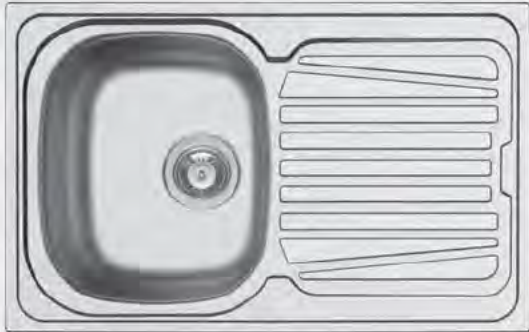

PRODUCT CODE: SDI-790-SE

CONFIGURATION: Single End Bowl  
SINK DIMENSIONS: 790mm x 500mm  
BOWL DIMENSIONS: 340mm x 400mm  
BOWL DEPTH: 150mm  
MINIMUM CUPBOARD DIMENSION: 450mm

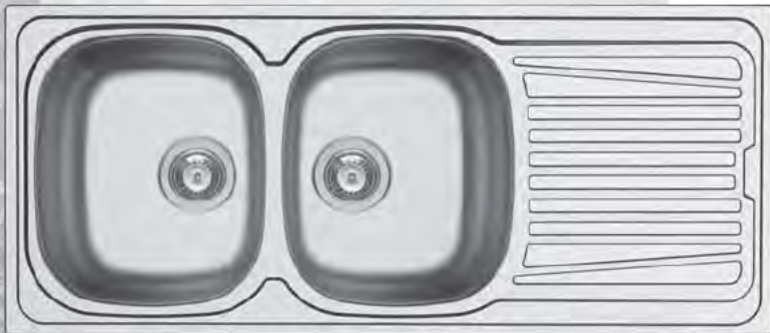
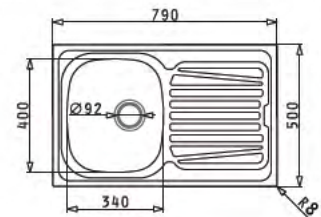

PRODUCT CODE: SDI-1160-DE

CONFIGURATION: Double End Bowls  
SINK DIMENSIONS: 1160mm x 500mm  
BOWL DIMENSIONS: 340mm x 400mm  
BOWL DEPTH: 150mm  
MINIMUM CUPBOARD DIMENSION: 800mm

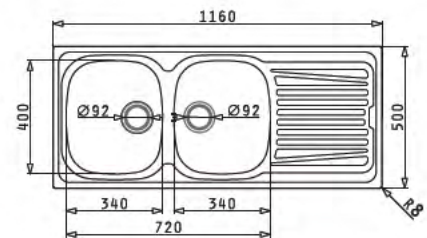

PRODUCT CODE: SDI-1380-DC

CONFIGURATION: Double Centre Bowls  
SINK DIMENSIONS: 1380mm x 480mm  
BOWL DIMENSIONS: 330mm x 395mm  
BOWL DEPTH: 170mm  
MINIMUM CUPBOARD DIMENSION: 800mm

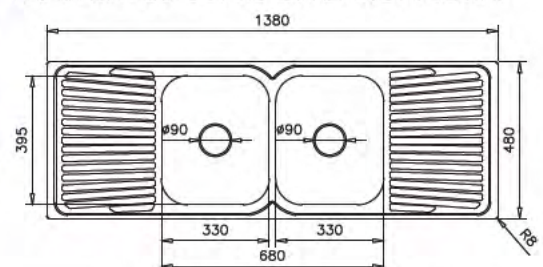

# KIBA SERIES

Drop In Preparation Bowls

FEATURES: Austenitic Stainless Steel, 90mm Waste Fitting.



PRODUCT CODE:

SPB-STDP

CONFIGURATION: Single Bowl

OUTER DIMENSIONS:  $\varnothing$ 450mm

BOWL DIMENSIONS:  $\varnothing$ 385mm

BOWL DEPTH: 150mm

MINIMUM CUPBOARD DIMENSION: 450mm

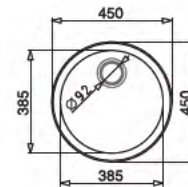

PRODUCT CODE:

SPB-THP

CONFIGURATION: Single Bowl with Tap Landing

OUTER DIMENSIONS:  $\varnothing$ 485mm

BOWL DIMENSIONS:  $\varnothing$ 385mm

BOWL DEPTH: 163mm

MINIMUM CUPBOARD DIMENSION: 450mm

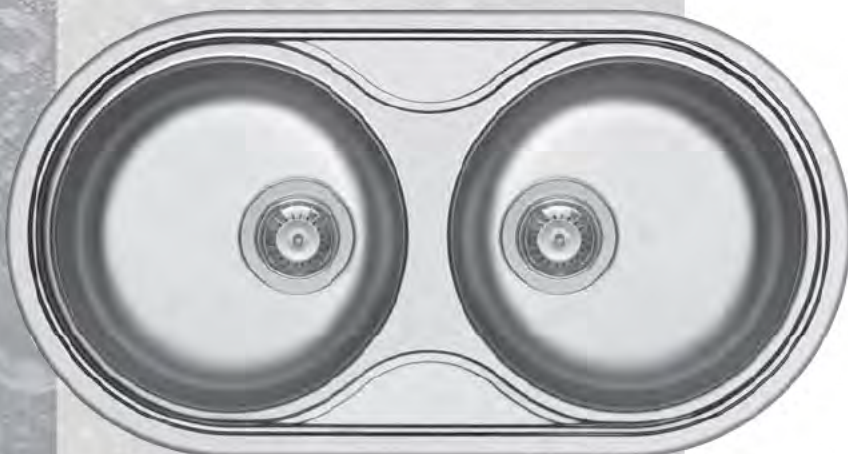

PRODUCT CODE:

SDI-850-DBR

CONFIGURATION: Double Bowls

OUTER DIMENSIONS: 850mm x 450mm

BOWL DIMENSIONS:  $\varnothing$ 360mm

BOWL DEPTH: 160mm

MINIMUM CUPBOARD DIMENSION: 800mm

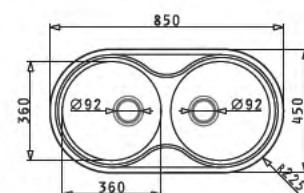

# LAUNDRY SERIES

Drop In Washtroughs

FEATURES: Austenitic Stainless Steel, 90mm Waste Fitting.



PRODUCT CODE:

SWT-RIBP

CONFIGURATION: Single Trough with Rib  
OUTER DIMENSIONS: 550mm x 450mm  
TROUGH DIMENSIONS: 400mm x 500mm  
TROUGH DEPTH: 230mm  
MINIMUM CUPBOARD DIMENSION: 600mm

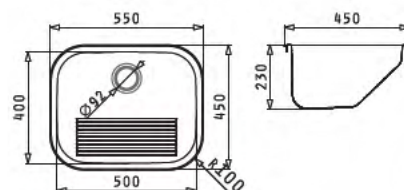

PRODUCT CODE:

SWT-SPACE

CONFIGURATION: Single Trough  
OUTER DIMENSIONS: 610mm x 480mm  
TROUGH DIMENSIONS: 500mm x 400mm  
TROUGH DEPTH: 200mm  
MINIMUM CUPBOARD DIMENSION: 550mm

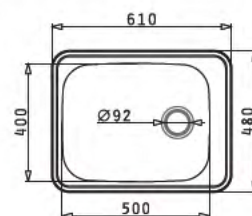

PRODUCT CODE:

SWT-AUSR

CONFIGURATION: Single Trough  
OUTER DIMENSIONS: 630mm x 470mm  
TROUGH DIMENSIONS: 540mm x 380mm  
TROUGH DEPTH: 240mm  
MINIMUM CUPBOARD DIMENSION: 600mm

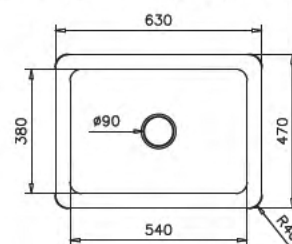

# LAUNDRY SERIES

## Wall Mounted Washtrough

FEATURES: Austenitic Stainless Steel.

90mm Waste Fitting, Wall Brackets.



PRODUCT CODE:

SWT-WM

CONFIGURATION: Single Trough with Rib

OUTER DIMENSIONS: 550mm x 450mm

TROUGH DIMENSIONS: 400mm x 500mm

TROUGH DEPTH: 230mm

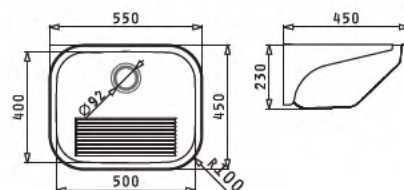

## Sit On Washtrough

40mm Waste Fitting, Brackets optional for Wall Mounting



PRODUCT CODE:

SWT-SON

CONFIGURATION: Single Trough

OUTER DIMENSIONS: 600mm x 500mm

TROUGH DIMENSIONS: 520mm x 415mm

TROUGH DEPTH: 230mm

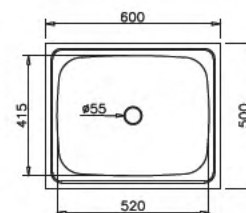

# CLASSIQUE PLUS RANGE

Sinks for the Deserving Home Owner





# ATHENA SERIES

Reversible Drop In Sinks

FEATURES: Austenitic Stainless Steel, Recessed Draining Ledge, Folded Edges for Added Strength, 90mm Waste Fitting.



PRODUCT CODE: SDI-790-SEA

CONFIGURATION: Single End Bowl  
 SINK DIMENSIONS: 790mm x 500mm  
 BOWL DIMENSIONS: 340mm x 400mm  
 BOWL DEPTH: 180mm  
 MINIMUM CUPBOARD DIMENSION: 450mm

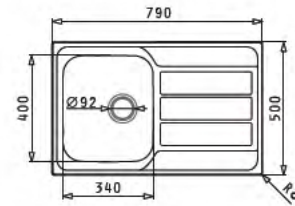

PRODUCT CODE: SDI-1160-DEA

CONFIGURATION: Double End Bowls  
 SINK DIMENSIONS: 1160mm x 500mm  
 BOWL DIMENSIONS: 340mm x 400mm  
 BOWL DEPTH: 165mm  
 MINIMUM CUPBOARD DIMENSION: 800mm

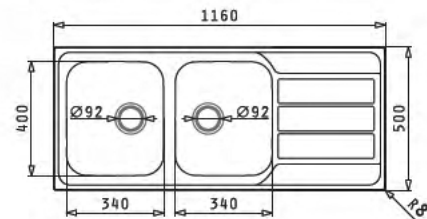

PRODUCT CODE: SDI-1350-DE

CONFIGURATION: Double End Bowls with Tidy Bowl  
 SINK DIMENSIONS: 1350mm x 480mm  
 BOWL DIMENSIONS: 340mm x 400mm  
 TIDY BOWL DIMENSIONS: 165mm x 290mm  
 BOWL DEPTH: 150mm and 120mm  
 MINIMUM CUPBOARD DIMENSION: 900mm

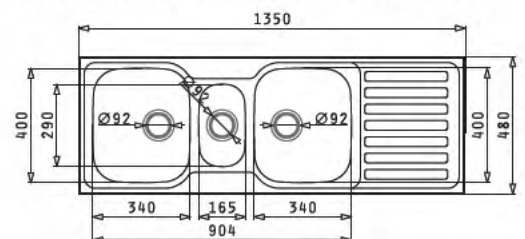

# AMALTIA SERIES

Drop In Sinks

FEATURES: Austenitic Stainless Steel, Recessed Draining Ledge  
Folded Edges for Added Strength, 90mm Waste Fitting.



PRODUCT CODE:

SDI-116-DLHB  
SDI-116-DRHB

CONFIGURATION: Double End Bowls

SINK DIMENSIONS: 1160mm x 500mm

BOWL DIMENSIONS: 450mm x 400mm  
and 300mm x 340mm

BOWL DEPTHS: 200mm and 170mm

MINIMUM CUPBOARD DIMENSION: 900mm

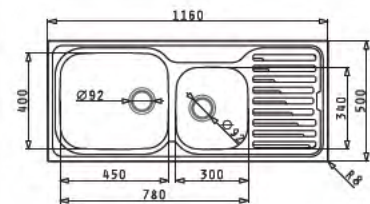

# CELESTE SERIES

Drop In Corner Sinks

FEATURES: Austenitic Stainless Steel, Recessed Draining Ledge  
Folded Edges for Added Strength, 90mm Waste Fitting.



PRODUCT CODE:

SDI-CORN-LH  
SDI-CORN-RH

CONFIGURATION: Double End Bowls

SINK DIMENSIONS: 830mm x 830mm

BOWL DIMENSIONS: 340mm x 390mm  
and 330 x 330mm

BOWL DEPTHS: 210mm and 215mm

MINIMUM CUPBOARD DIMENSION: 800mm

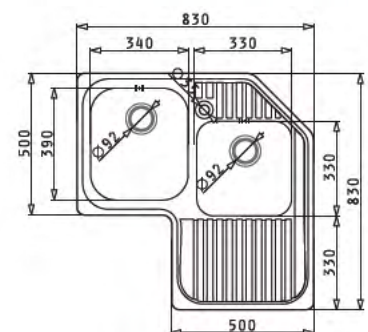

# HERCULES SERIES

Reversible Drop In Sinks

FEATURES: Austenitic Stainless Steel, Recessed Draining Ledge  
Folded Edges for Added Strength, 90mm Waste Fitting.



PRODUCT CODE: SDI-1450-DE

CONFIGURATION: Double End Bowls  
SINK DIMENSIONS: 1450mm x 500mm  
BOWL DIMENSIONS: 430mm x 400mm  
BOWL DEPTH: 200mm  
MINIMUM CUPBOARD DIMENSION: 1000mm

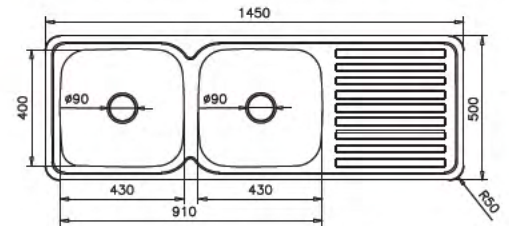

PRODUCT CODE: SDI-1500-DC

CONFIGURATION: Double Centre Bowls  
SINK DIMENSIONS: 1500mm x 500mm  
BOWL DIMENSIONS: 350mm x 410mm  
BOWL DEPTH: 170mm  
MINIMUM CUPBOARD DIMENSION: 800mm

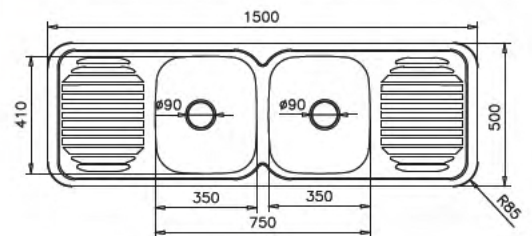

# CLASSIQUE DESIGNER RANGE

Sinks for the Distinguished Home Owner



# CRYSTALON SERIES

Reversible Drop In Sinks

FEATURES: Tempered Glass Surface, Austenitic Stainless Steel, Satin Finish Bowls, Large Deep Bowls, 90mm Waste Fitting.



PRODUCT CODE: SDI-860-SBGB

CONFIGURATION: Single End Bowls  
SINK DIMENSIONS: 860mm x 500mm  
BOWL DIMENSIONS: 340mm x 400mm  
BOWL DEPTH: 200mm  
MINIMUM CUPBOARD DIMENSION: 500mm

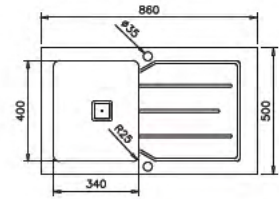

PRODUCT CODE: SDI-860-SBGW

CONFIGURATION: Single End Bowl  
SINK DIMENSIONS: 860mm x 500mm  
BOWL DIMENSIONS: 340mm x 400mm  
BOWL DEPTH: 200mm  
MINIMUM CUPBOARD DIMENSION: 500mm



PRODUCT CODE: SDI-1160-DBGB

CONFIGURATION: Double End Bowls  
SINK DIMENSIONS: 1160mm x 500mm  
BOWL DIMENSIONS: 340mm x 400mm  
BOWL DEPTH: 200mm  
MINIMUM CUPBOARD DIMENSION: 800mm

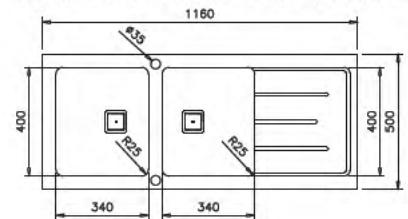

PRODUCT CODE: SDI-1160-DBGW

CONFIGURATION: Reversible Double End Bowls  
SINK DIMENSIONS: 1160mm x 500mm  
BOWL DIMENSIONS: 340mm x 400mm  
BOWL DEPTH: 200mm  
MINIMUM CUPBOARD DIMENSION: 800mm

# OLYNTHOS SERIES

Fabricated Flushmount Sinks

FEATURES: Austenitic Stainless Steel, Brushed Finish, Hygienic 25 Degrees Radius Corners on Bowls, 90mm Waste Fitting.



PRODUCT CODE:

SDI-1000-SFL  
SDI-1000-SFR

CONFIGURATION: Single End Bowl

SINK DIMENSIONS: 1000mm x 520mm

BOWL DIMENSIONS: 450mm x 400mm

BOWL DEPTH: 200mm

MINIMUM CUPBOARD DIMENSION: 600mm

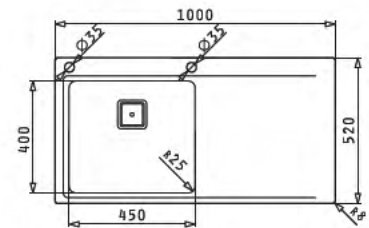

PRODUCT CODE:

SDI-1160-DFPL  
SDI-1160-DFPR

CONFIGURATION: Double End Bowls

SINK DIMENSIONS: 1160mm x 520mm

BOWL DIMENSIONS: 340mm x 400mm

BOWL DEPTH: 200mm

MINIMUM CUPBOARD DIMENSION: 800mm

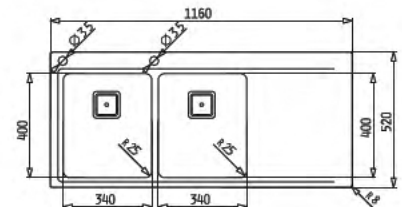

# LYDIA SERIES

Undermount Sinks

FEATURES: Austenitic Stainless Steel, Brushed Finish, Hygienic 25 Degree Radius Corners on Bowls, 90mm Waste Fitting.



PRODUCT CODE: SDI-400-SUM

CONFIGURATION: Single Bowl Undermount  
SINK DIMENSIONS: 440mm x 440mm  
BOWL DIMENSIONS: 400mm x 400mm  
BOWL DEPTH: 200mm  
MINIMUM CUPBOARD DIMENSION: 450mm

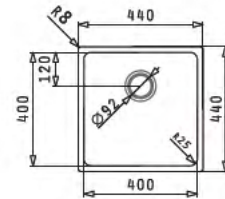

PRODUCT CODE: SDI-450-SUML

CONFIGURATION: Single Bowl Undermount  
SINK DIMENSIONS: 490mm x 440mm  
BOWL DIMENSIONS: 450mm x 400mm  
BOWL DEPTH: 200mm  
MINIMUM CUPBOARD DIMENSION: 500mm

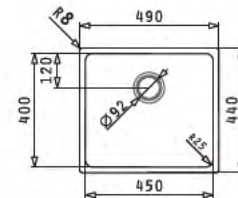

PRODUCT CODE: SDI-776-DUM

CONFIGURATION: Double Bowl Undermount  
SINK DIMENSIONS: 766mm x 456mm  
BOWL DIMENSIONS: 340mm x 400mm  
BOWL DEPTH: 200mm  
MINIMUM CUPBOARD DIMENSION: 800mm

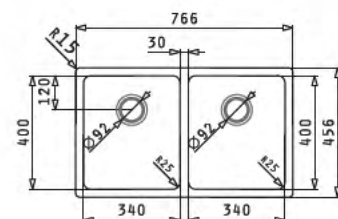

# IRIS SERIES

Undermount Sinks

FEATURES: Austenitic Stainless Steel, Satin Finish,  
90mm Waste Fitting.



PRODUCT CODE: SDI-290-SUM

CONFIGURATION: Single Tidy Bowl Undermount  
SINK DIMENSIONS: 304mm x 180mm  
BOWL DIMENSIONS: 288mm x 165mm  
BOWL DEPTH: 120mm  
MINIMUM CUPBOARD DIMENSION: 300mm

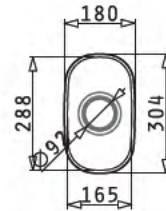

PRODUCT CODE: SDI-450-SUM

CONFIGURATION: Single Bowl Undermount  
SINK DIMENSIONS: 472mm x 422mm  
BOWL DIMENSIONS: 450mm x 400mm  
BOWL DEPTH: 200mm  
MINIMUM CUPBOARD DIMENSION: 500mm

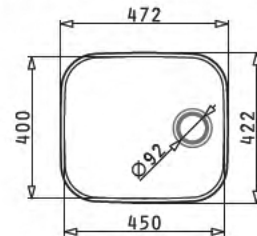

PRODUCT CODE: SDI-770-DUM

CONFIGURATION: Double Bowl Undermount  
SINK DIMENSIONS: 766mm x 456mm  
BOWL DIMENSIONS: 340mm x 400mm  
BOWL DEPTH: 180mm  
MINIMUM CUPBOARD DIMENSION: 800mm

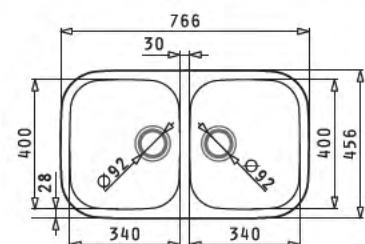





# OCTI

plumbing kit



SSKIT-OCTI-1



SSKIT-OCTI-2



SSKIT-OCTI-3

## SPACE SAVING WASTE KITS

PRODUCT FEATURES:

- Interlocking PVC pipes for 40mm and 90mm waste outlets
- Space saving
- Easy to install
- Can be used on all sinks

PRODUCT CODE	WASTE OUTLET
SSKIT-OCTI-1	Single Bowl
SSKIT-OCTI-2	Double Bowl
SSKIT-OCTI-3	Triple Bowl



# stainless



SS-CLEAN

## STAINLESS STEEL CLEANING CRÈME

PRODUCT FEATURES:

- Gentle yet effective for cleaning kitchen sinks, prep bowls, washtroughs and other stainless steel products ie cutlery, bread tins, mixing bowls and canisters.
- Available in a 250ml tub.



**Electrolux SA (Pty) Ltd**

***inland division***

3 Aberdeen Road,  
Industrial Sites,  
Benoni

Tel: (011) 897 4600

***eastern cape division***

39-41 Leadwood Crescent,  
Fairview,  
Port Elizabeth

Tel: (041) 399 4000

Fax: (041) 367 1005

***western cape division***

15 Purdey Road,  
Sheffield Business Park, Phillippi,  
Cape Town

Tel: (021) 690 2700

Fax: (021) 690 2800

***kwazulu-natal division***

814 Peter Close,  
Springfield Park,  
Durban

Tel: (031) 574 8700

Fax: (031) 574 8750