



stainless

DOMESTIC SINK RANGE

Style and Functionality All-In-One



CLASSIQUE DESIGNER



CLASSIQUE PLUS



CLASSIQUE

INDEX

CLASSIQUE RANGE	1
Sparta Series	2
Kiba Series	3
Laundry Series	4/5
CLASSIQUE PLUS RANGE	6
Athena Series	7
Amaltia Series	8
Hercules Series	9
CLASSIQUE DESIGNER RANGE	10
Crystalon Series	11
Olynthos Series	12
Lydia Series	13
Iris Series	14
OCTI PLUMBING KIT	15
STAINLESS STEEL CLEANING CRÉME	15
WASTE WONDER FOOD WASTE DISPOSER	16

CLASSIQUE RANGE

Sinks for the Discerning Home Owner



SPARTA SERIES

Reversible Drop In Sinks

FEATURES: Austenitic Stainless Steel, Recessed Drainage Ledge, Folded Edges for Added Strength, 90mm Waste Fitting.

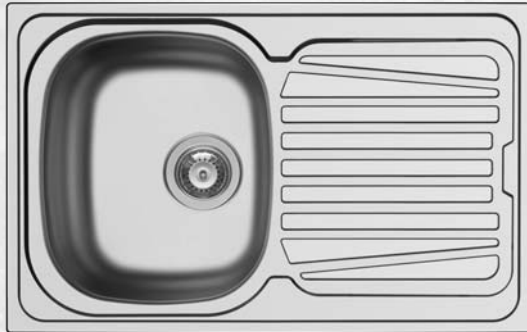

PRODUCT CODE: SDI-790-SE

CONFIGURATION: Single End Bowl
SINK DIMENSIONS: 790mm x 500mm
BOWL DIMENSIONS: 340mm x 400mm
BOWL DEPTH: 150mm
MINIMUM CUPBOARD DIMENSION: 450mm

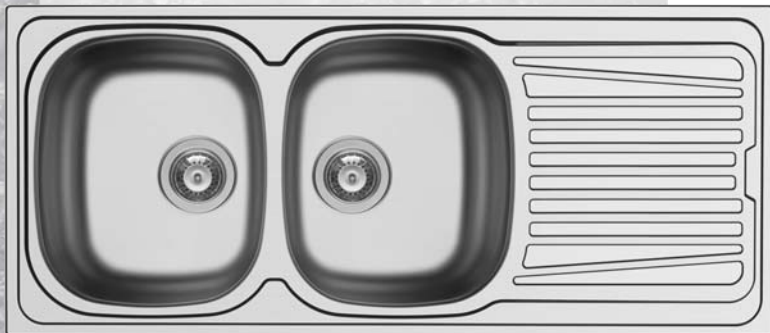
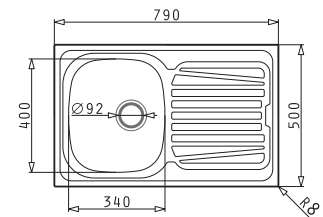

PRODUCT CODE: SDI-1160-DE

CONFIGURATION: Double End Bowls
SINK DIMENSIONS: 1160mm x 500mm
BOWL DIMENSIONS: 340mm x 400mm
BOWL DEPTH: 150mm
MINIMUM CUPBOARD DIMENSION: 800mm

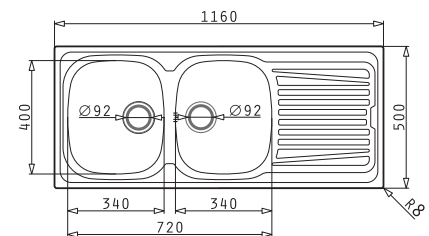

PRODUCT CODE: SDI-1380-DC

CONFIGURATION: Double Centre Bowls
SINK DIMENSIONS: 1380mm x 480mm
BOWL DIMENSIONS: 330mm x 395mm
BOWL DEPTH: 170mm
MINIMUM CUPBOARD DIMENSION: 800mm

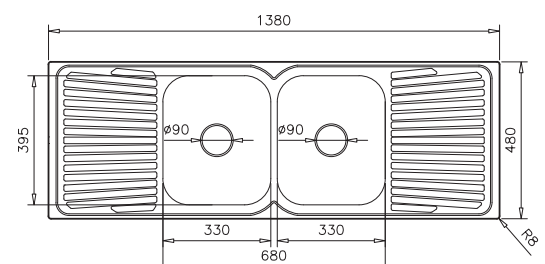

KIBA SERIES

Drop In Preparation Bowls

FEATURES: Austenitic Stainless Steel, 90mm Waste Fitting.



PRODUCT CODE: SPB-STDP

CONFIGURATION: Single Bowl
OUTER DIMENSIONS: Ø450mm
BOWL DIMENSIONS: Ø385mm
BOWL DEPTH: 150mm
MINIMUM CUPBOARD DIMENSION: 450mm

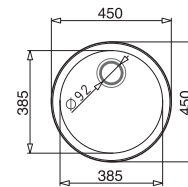

PRODUCT CODE: SPB-THP

CONFIGURATION: Single Bowl with Tap Landing
OUTER DIMENSIONS: Ø485mm
BOWL DIMENSIONS: Ø385mm
BOWL DEPTH: 163mm
MINIMUM CUPBOARD DIMENSION: 450mm

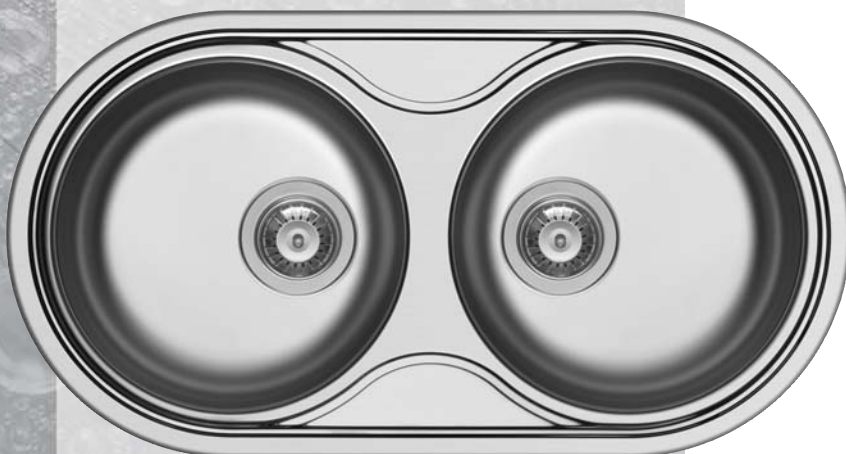
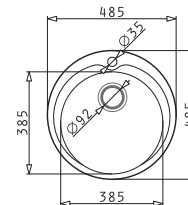

PRODUCT CODE: SDI-850-DBR

CONFIGURATION: Double Bowls
OUTER DIMENSIONS: 850mm x 450mm
BOWL DIMENSIONS: Ø360mm
BOWL DEPTH: 160mm
MINIMUM CUPBOARD DIMENSION: 800mm

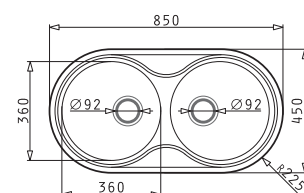

LAUNDRY SERIES

Drop In Washtroughs

FEATURES: Austenitic Stainless Steel, 90mm Waste Fitting.



PRODUCT CODE:

SWT-RIBP

CONFIGURATION: Single Trough with Rib
OUTER DIMENSIONS: 550mm x 450mm
TROUGH DIMENSIONS: 400mm x 500mm
TROUGH DEPTH: 230mm
MINIMUM CUPBOARD DIMENSION: 600mm

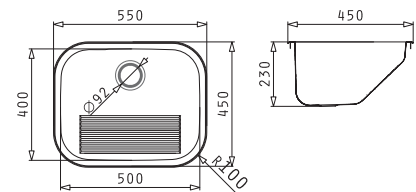

PRODUCT CODE:

SWT-SPACE

CONFIGURATION: Single Trough
OUTER DIMENSIONS: 610mm x 480mm
TROUGH DIMENSIONS: 500mm x 400mm
TROUGH DEPTH: 200mm
MINIMUM CUPBOARD DIMENSION: 550mm

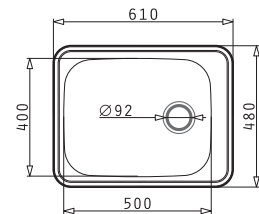

PRODUCT CODE:

SWT-AUSR

CONFIGURATION: Single Trough
OUTER DIMENSIONS: 630mm x 470mm
TROUGH DIMENSIONS: 540mm x 380mm
TROUGH DEPTH: 240mm
MINIMUM CUPBOARD DIMENSION: 600mm

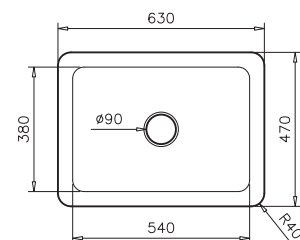

LAUNDRY SERIES

Wall Mounted Washtrough

FEATURES: Austenitic Stainless Steel.

90mm Waste Fitting, Wall Brackets.



PRODUCT CODE:

SWT-WM

CONFIGURATION: Single Trough with Rib
OUTER DIMENSIONS: 550mm x 450mm
TROUGH DIMENSIONS: 400mm x 500mm
TROUGH DEPTH: 230mm

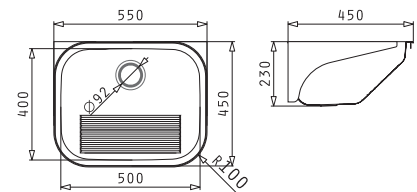

Sit On Washtrough

40mm Waste Fitting, Brackets optional for Wall Mounting



PRODUCT CODE:

SWT-SON

CONFIGURATION: Single Trough
OUTER DIMENSIONS: 600mm x 500mm
TROUGH DIMENSIONS: 520mm x 415mm
TROUGH DEPTH: 230mm

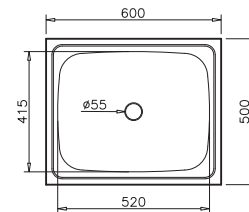

CLASSIQUE PLUS RANGE

Sinks for the Deserving Home Owner



ATHENA SERIES

Reversible Drop In Sinks

FEATURES: Austenitic Stainless Steel, Recessed Draining Ledge, Folded Edges for Added Strength, 90mm Waste Fitting.



PRODUCT CODE: SDI-790-SEA

CONFIGURATION: Single End Bowl
 SINK DIMENSIONS: 790mm x 500mm
 BOWL DIMENSIONS: 340mm x 400mm
 BOWL DEPTH: 180mm
 MINIMUM CUPBOARD DIMENSION: 450mm

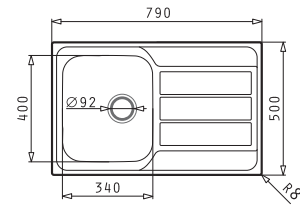

PRODUCT CODE: SDI-1160-DEA

CONFIGURATION: Double End Bowls
 SINK DIMENSIONS: 1160mm x 500mm
 BOWL DIMENSIONS: 340mm x 400mm
 BOWL DEPTH: 165mm
 MINIMUM CUPBOARD DIMENSION: 800mm

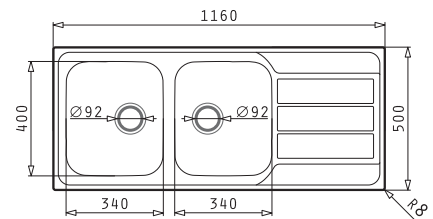

PRODUCT CODE: SDI-1350-DE

CONFIGURATION: Double End Bowls with Tidy Bowl
 SINK DIMENSIONS: 1350mm x 480mm
 BOWL DIMENSIONS: 340mm x 400mm
 TIDY BOWL DIMENSIONS: 165mm x 290mm
 BOWL DEPTH: 150mm and 120mm
 MINIMUM CUPBOARD DIMENSION: 900mm

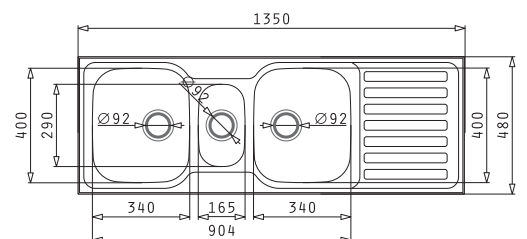

AMALTIA SERIES

Drop In Sinks

FEATURES: Austenitic Stainless Steel, Recessed Draining Ledge
Folded Edges for Added Strength, 90mm Waste Fitting.



PRODUCT CODE:

SDI-116-DLHB
SDI-116-DRHB

CONFIGURATION: Double End Bowls
SINK DIMENSIONS: 1160mm x 500mm
BOWL DIMENSIONS: 450mm x 400mm
and 300mm x 340mm
BOWL DEPTHS: 200mm and 170mm
MINIMUM CUPBOARD DIMENSION: 900mm

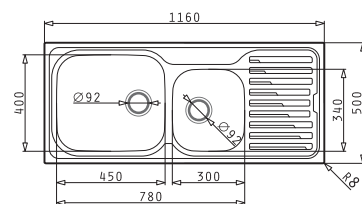

CELESTE SERIES

Drop In Corner Sinks

FEATURES: Austenitic Stainless Steel, Recessed Draining Ledge
Folded Edges for Added Strength, 90mm Waste Fitting.



PRODUCT CODE:

SDI-CORN-LH
SDI-CORN-RH

CONFIGURATION: Double End Bowls
SINK DIMENSIONS: 830mm x 830mm
BOWL DIMENSIONS: 340mm x 390mm
and 330 x 330mm
BOWL DEPTHS: 210mm and 215mm
MINIMUM CUPBOARD DIMENSION: 800mm

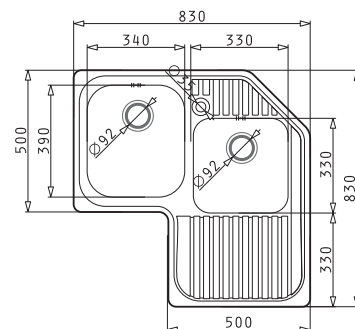

HERCULES SERIES

Reversible Drop In Sinks

FEATURES: Austenitic Stainless Steel, Recessed Draining Ledge
Folded Edges for Added Strength, 90mm Waste Fitting.



PRODUCT CODE: SDI-1450-DE

CONFIGURATION: Double End Bowls
SINK DIMENSIONS: 1450mm x 500mm
BOWL DIMENSIONS: 430mm x 400mm
BOWL DEPTH: 200mm
MINIMUM CUPBOARD DIMENSION: 1000mm

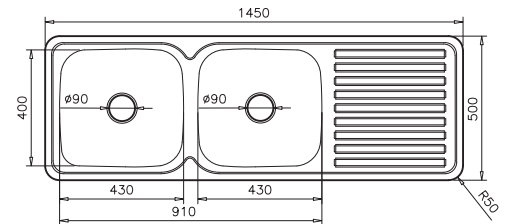

PRODUCT CODE: SDI-1500-DC

CONFIGURATION: Double Centre Bowls
SINK DIMENSIONS: 1500mm x 500mm
BOWL DIMENSIONS: 350mm x 410mm
BOWL DEPTH: 170mm
MINIMUM CUPBOARD DIMENSION: 800mm

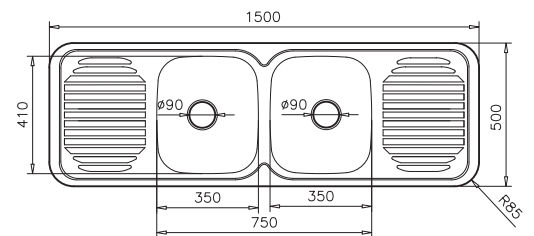

CLASSIQUE DESIGNER RANGE

Sinks for the Distinguished Home Owner



CRYSTALON SERIES

Reversible Drop In Sinks

FEATURES: Tempered Glass Surface, Austenitic Stainless Steel, Satin Finish Bowls, Large Deep Bowls, 90mm Waste Fitting.



PRODUCT CODE: SDI-860-SBGB

CONFIGURATION: Single End Bowls
SINK DIMENSIONS: 860mm x 500mm
BOWL DIMENSIONS: 340mm x 400mm
BOWL DEPTH: 200mm
MINIMUM CUPBOARD DIMENSION: 500mm

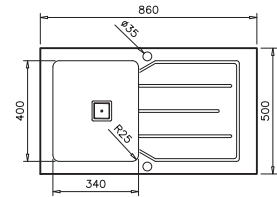

PRODUCT CODE: SDI-860-SBGW

CONFIGURATION: Single End Bowl
SINK DIMENSIONS: 860mm x 500mm
BOWL DIMENSIONS: 340mm x 400mm
BOWL DEPTH: 200mm
MINIMUM CUPBOARD DIMENSION: 500mm



PRODUCT CODE: SDI-1160-DBGB

CONFIGURATION: Double End Bowls
SINK DIMENSIONS: 1160mm x 500mm
BOWL DIMENSIONS: 340mm x 400mm
BOWL DEPTH: 200mm
MINIMUM CUPBOARD DIMENSION: 800mm

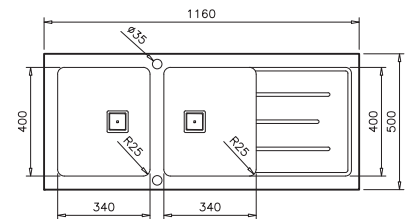

PRODUCT CODE: SDI-1160-DBGW

CONFIGURATION: Reversible Double End Bowls
SINK DIMENSIONS: 1160mm x 500mm
BOWL DIMENSIONS: 340mm x 400mm
BOWL DEPTH: 200mm
MINIMUM CUPBOARD DIMENSION: 800mm

OLYNTHOS SERIES

Fabricated Flushmount Sinks

FEATURES: Austenitic Stainless Steel, Brushed Finish, Hygienic 25 Degrees Radius Corners on Bowls, 90mm Waste Fitting.



PRODUCT CODE:

SDI-1000-SFL
SDI-1000-SFR

CONFIGURATION: Single End Bowl

SINK DIMENSIONS: 1000mm x 520mm

BOWL DIMENSIONS: 450mm x 400mm

BOWL DEPTH: 200mm

MINIMUM CUPBOARD DIMENSION: 600mm

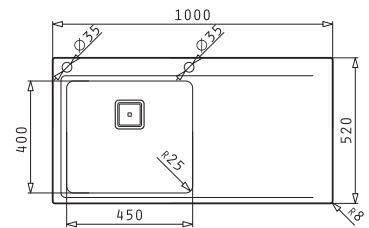

PRODUCT CODE:

SDI-1160-DFPL
SDI-1160-DFPR

CONFIGURATION: Double End Bowls

SINK DIMENSIONS: 1160mm x 520mm

BOWL DIMENSIONS: 340mm x 400mm

BOWL DEPTH: 200mm

MINIMUM CUPBOARD DIMENSION: 800mm

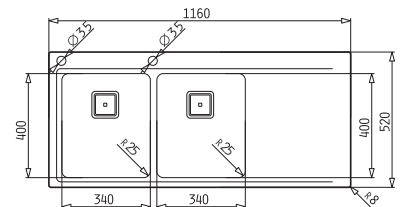

LYDIA SERIES

Undermount Sinks

FEATURES: Austenitic Stainless Steel, Brushed Finish, Hygienic 25 Degree Radius Corners on Bowls, 90mm Waste Fitting.



PRODUCT CODE: SDI-400-SUM

CONFIGURATION: Single Bowl Undermount
SINK DIMENSIONS: 440mm x 440mm
BOWL DIMENSIONS: 400mm x 400mm
BOWL DEPTH: 200mm
MINIMUM CUPBOARD DIMENSION: 450mm

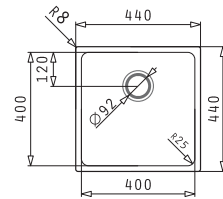

PRODUCT CODE: SDI-450-SUML

CONFIGURATION: Single Bowl Undermount
SINK DIMENSIONS: 490mm x 440mm
BOWL DIMENSIONS: 450mm x 400mm
BOWL DEPTH: 200mm
MINIMUM CUPBOARD DIMENSION: 500mm

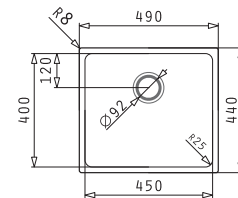

PRODUCT CODE: SDI-776-DUM

CONFIGURATION: Double Bowl Undermount
SINK DIMENSIONS: 766mm x 456mm
BOWL DIMENSIONS: 340mm x 400mm
BOWL DEPTH: 200mm
MINIMUM CUPBOARD DIMENSION: 800mm

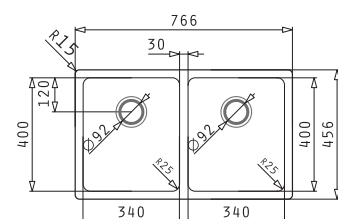

IRIS SERIES

Undermount Sinks

FEATURES: Austenitic Stainless Steel, Satin Finish,
90mm Waste Fitting.



PRODUCT CODE: SDI-290-SUM

CONFIGURATION: Single Tidy Bowl Undermount
SINK DIMENSIONS: 304mm x 180mm
BOWL DIMENSIONS: 288mm x 165mm
BOWL DEPTH: 120mm
MINIMUM CUPBOARD DIMENSION: 300mm

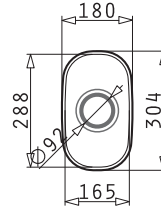

PRODUCT CODE: SDI-450-SUM

CONFIGURATION: Single Bowl Undermount
SINK DIMENSIONS: 472mm x 422mm
BOWL DIMENSIONS: 450mm x 400mm
BOWL DEPTH: 200mm
MINIMUM CUPBOARD DIMENSION: 500mm

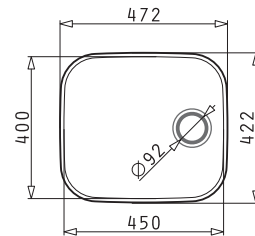

PRODUCT CODE: SDI-770-DUM

CONFIGURATION: Double Bowl Undermount
SINK DIMENSIONS: 766mm x 456mm
BOWL DIMENSIONS: 340mm x 400mm
BOWL DEPTH: 180mm
MINIMUM CUPBOARD DIMENSION: 800mm

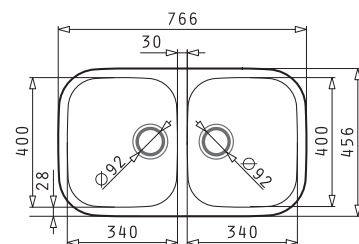



OCTI plumbing kit



SSKIT-OCTI-1

SSKIT-OCTI-2



SSKIT-OCTI-3

SPACE SAVING WASTE KITS

PRODUCT FEATURES:

- Interlocking PVC pipes for 40mm and 90mm waste outlets
- Space saving
- Easy to install
- Can be used on all sinks

PRODUCT CODE	WASTE OUTLET
SSKIT-OCTI-1	Single Bowl
SSKIT-OCTI-2	Double Bowl
SSKIT-OCTI-3	Triple Bowl



stainless



SS-CLEAN

STAINLESS STEEL CLEANING CRÈME

PRODUCT FEATURES:

- Gentle yet effective for cleaning kitchen sinks, prep bowls, washtroughs and other stainless steel products ie cutlery, bread tins, mixing bowls and canisters.
- Available in a 250ml tub.



WasteWonder

DOMESTIC FOOD WASTE DISPOSER

ELECTRIC DOMESTIC FOOD WASTE DISPOSER

PRODUCT FEATURES:

- Two Models to Choose from:
 - Model 2600 with a 1/2 horsepower motor, ideal for small families of four or lower.
 - Model 3300 with a 3/4 horsepower motor, ideal for larger families of five and higher.
- Can be installed on sinks and prep-bowls with:
 - 90mm waste outlets
 - 40mm waste outlets where the outlet is located not too close to the inner curvature of bowl and the outlet can be cut to a 90mm circular outlet.
- Soft foods, poultry bones, fish heads/bones and shellfish shells, eggs and nut shells, vegetable/fruit peels and pips, mielie/corn cobs, coffee grounds and tea leaves can all be quick and easily disposed of.
- Self-cleaning and scours it's internal parts with each use.
- Grade 316 stainless steel components for food and medical applications.

PRODUCT SPECIFICATION DATA:

- The powerful yet economic permanent motors spin the stainless steel grind ring to 2600 rpm on the Model 2600 and 2700 rpm on the Model 3300. The fast grinding action by the impellers (no blades), chops the waste into 2mm to 3mm particles with minimum electricity usage and the particles flush through the plumbing system with little water usage.
- Supplied with a complete sink mount assembly for a 90mm waste outlet, 800mm 3-core electrical cable and discharge elbow pipe.
- Manufactured to ISO 9001 Management Standard.

	MODEL 2600	MODEL 3300
Product Code:	SS-WOND-2600	SS-WOND-3300
Motor Horsepower:	1/2 Hp	3/4 Hp
Motor Speed :	2600 R.P.M	2700 R.P.M
Voltage:	220-240v	220-240v
Hz:	50/60	50/60
Amps:	2.25 Amp	3.0 Amp
Watts:	520W(100) 5.2 (110-220), 2.25(220-240)	520W(100) 5.2 (110-220), 2.25(220-240)
Motor Type:	Permanent Magnet	Permanent Magnet
Sink Flange:	Stainless Steel & Celecon	Stainless Steel & Celecon
Stopper:	Positive Seal	Positive Seal
Splash Guard:	Removable	Removable
Feed type:	Continuous	Continuous
Grind Ring:	Stainless Steel	Stainless Steel
Swivel Impellers:	Stainless Steel	Stainless Steel
Turntable:	Stainless Steel	Stainless Steel
Grinding Chamber:	Corrosion Proof Glass Filled Polyester	Corrosion Proof Glass Filled Polyester
Overload Protector:	Manual Reset Type	Manual Reset Type
Warranty:	2 years	2 years



SS-WOND-2600

SS-WOND-3300



ACCESSORIES:

- Optional Air-Switch with control box, which can be mounted into a wooden counter top or into a flat portion of the sink top.



SS-AIRSWITCH





KWIKOT (PTY) LTD
INLAND DIVISION
P.O. Box 1016
Benoni
1500
Tel: 011 897 4600
Fax: 011 914 4750

After Sales Service :
0861KWIKOT (594568)

KWIKOT (PTY) LTD
KWAZULU-NATAL
DIVISION
P.O. Box 47366
Greyville
Durban
4023
Tel: 031 574 8700
Fax: 031 574 8750

KWIKOT (PTY) LTD
EASTERN CAPE
DIVISION
P.O. Box 29142
Sunridge Park
Port Elizabeth
6008
Tel: 041 399 4000
Fax: 041 367 1005

KWIKOT (PTY) LTD
WESTERN CAPE
DIVISION
P.O. Box 32072
Ottery
Cape Town
7808
Tel: 021 690 2700
Fax: 021 690 2800

www.kwikot.com