

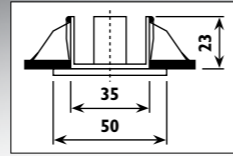

CA10

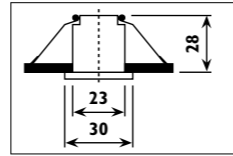

CA20



CA30

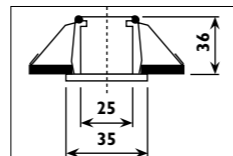

CA31

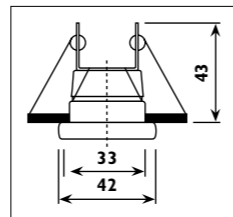

CA40

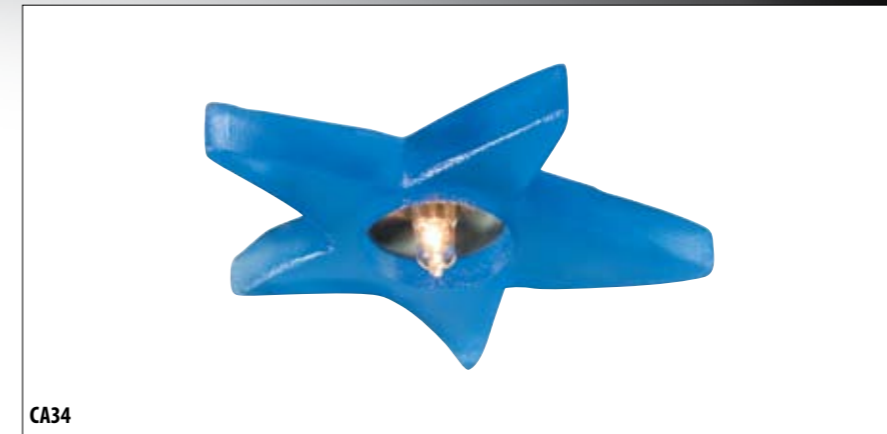
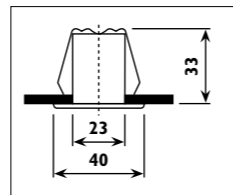

CA34

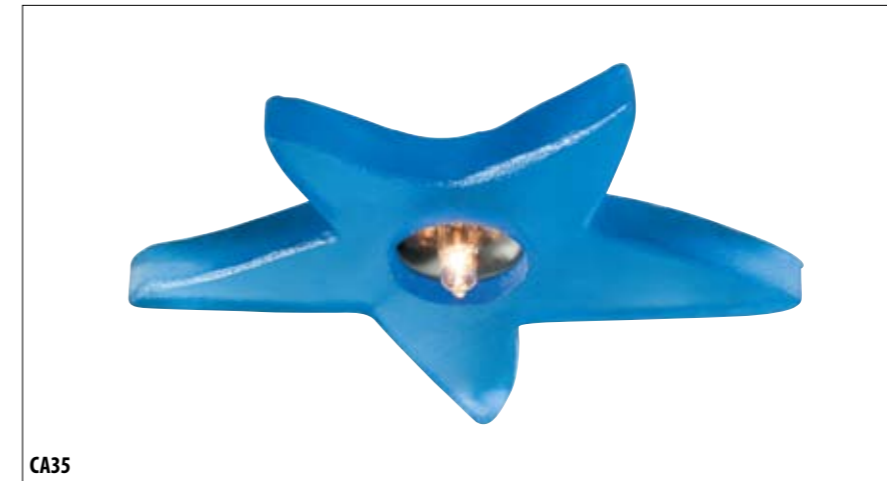
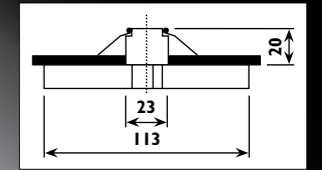

CA35

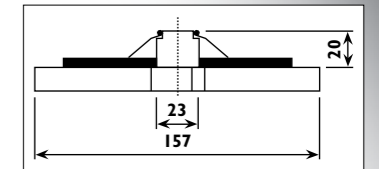

Colour options for CA34 and CA35

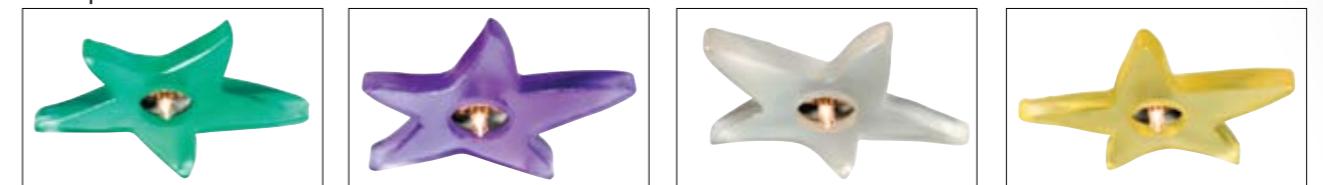

CA10 Steel body												
CA20 - CA30 Aluminium body												
CA31 Steel and glass body												
CA40 Steel and aluminium body with anodised aluminium reflector												
Code	Class	IP	QC	Lamp/s 12v G4 bi-pin	Transformer Required	Cutout (mm)	Brass	Chrome	Satin chrome	Satin silver	White	Accessories Slab box & Slab lid N??
CA10	III	20	21	10w	•	Ø 40	•	•	•	•	•	•
CA20	III	20	21	10w	•	Ø 25	•	•	•	•	•	•
CA30	III	20	21	10w	•	Ø 25	•	•	•	•	•	•
CA31	III	20	21	20w	•	Ø 33					•	•
CA40	III	20	21	10w	•	Ø 25	•	•	•	•	•	•

Aluminium and polyresin body												
Code	Class	IP	QC	Lamp/s 12v G4 bi-pin	Transformer Required	Cutout (mm)	Blue	Lemon	Lilac	Lime	White	Accessories Slab box & Slab lid N??
CA34	III	20	21	10w	•	Ø 25	•	•	•	•	•	•
CA35	III	20	21	10w	•	Ø 25	•	•	•	•	•	•



CE10



Steel surface cup accessory  
CE/CUP + CE10

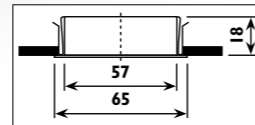

CE22

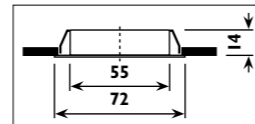

CE30

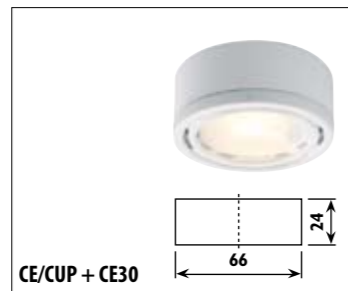

CE/CUP + CE30

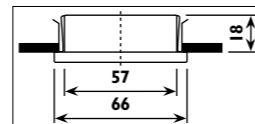

CG14

Colour options

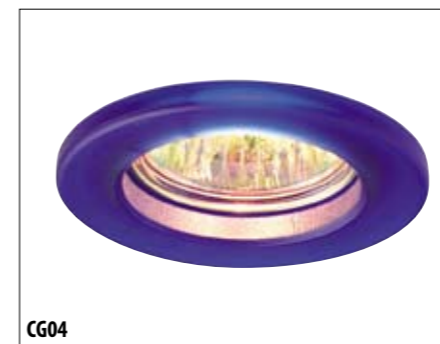
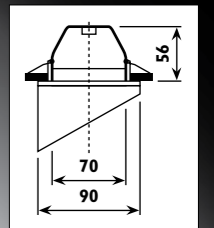

CG04

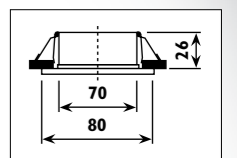

CE10 Steel body with matt aluminium reflector															
CE22 Steel body with glass lens															
CE30 Plastic ring, aluminium body and reflector with glass lens															
Code	Class	IP	QC	Lamp/s 12v G4 bi-pin	Transformer Required	Cutout (mm)	Clearance Height (mm)	Colour/s						Accessories	
								Black	Brass	Chrome	Satin chrome	Satin silver	White	CE/CUP Surface cup	Slab box & Slab lid
CE10	III	20	21	20w	•	Ø 60		•	•	•	•	•	•	•	•
CE22	III	20	21	20w	•	Ø 60	14				•				•
CE30	III	20	13	20w	•	Ø 60		•	•	•	•	•	•	•	•

Steel and glass body													
Code	Class	IP	QC	Lamp/s 12v GU5,3 MR16	Transformer Required	Cutout (mm)	Clearance Height (mm)	Blue	White	Chrome body/ Clear glass	Accessories		
CG04	III	20	23	50w	•	Ø 70	62	•	•				•
CG14	III	20	22	50w	•	Ø 75				•			•



CG06

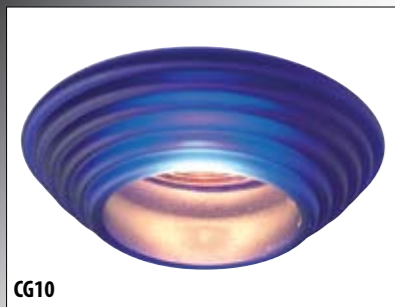
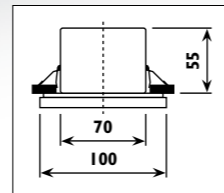

CG10

Colour options

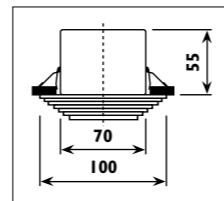
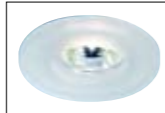

CG12

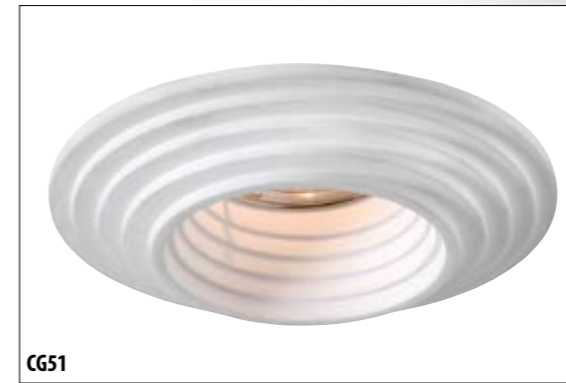
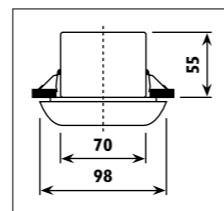

CG51

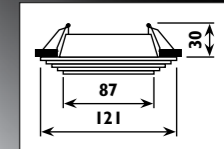

CG53

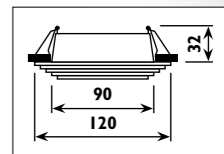

Steel and glass body									
Code	Class	IP	QC	Lamp/s 12v GU5,3 MR16	Transformer Required	Cutout (mm)	Colour/s Blue White		Accessories Slab box & Slab lid N??
CG06	III	20	23	50w	•	Ø 80	•	•	•
CG10	III	20	23	50w	•	Ø 80	•	•	•
CG12	III	20	23	50w	•	Ø 80	•	•	•

Reinforced plaster body									
Code	Class	IP	QC	Lamp/s 12v GU5,3 MR16	Transformer Required	Cutout (mm)	Clearance Height (mm)	Colour/s White	Accessories Slab box & Slab lid N??
CG51	III	20	32	50w	•	Ø 90	64	•	•
CG53	III	20	32	50w	•	96 x 96	58	•	•

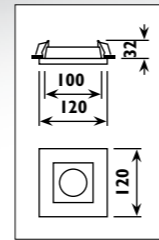

CG55

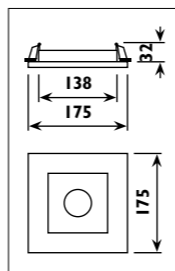
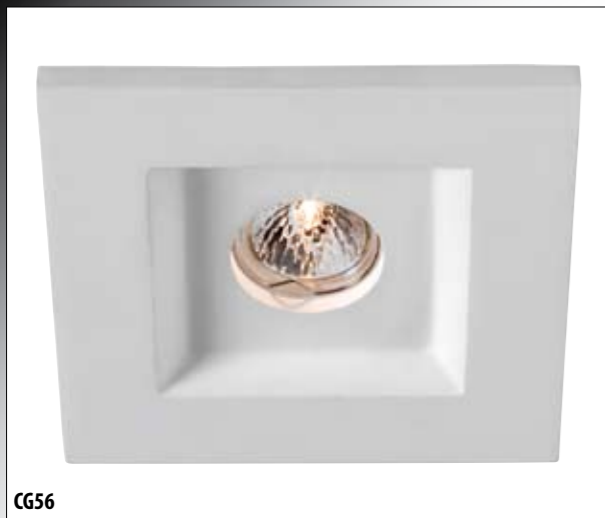

CG56

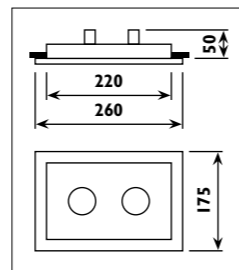
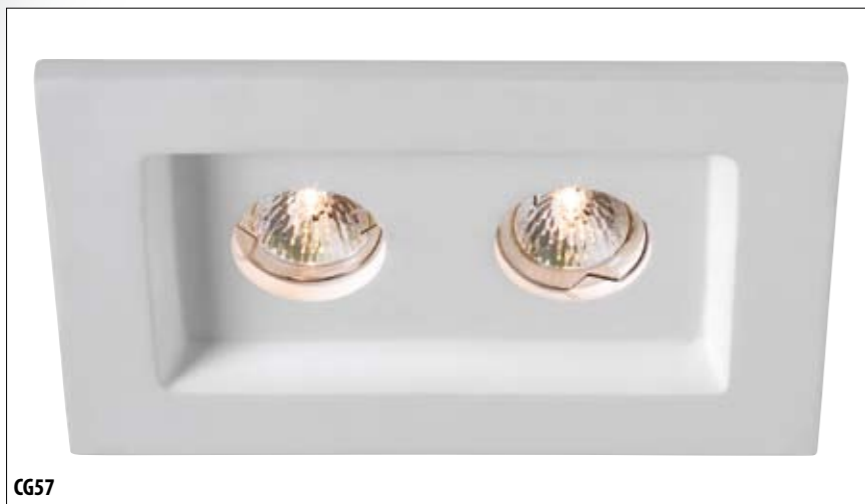

CG57

Reinforced plaster body								
Code	Class	IP	QC	Lamp/s	Transformer	Cutout	Clearance	Colour/s
				12v GU5,3 MR16	Required	(mm)	Height (mm)	White
CG55	III	20	32	1 x 50w	•	102 x 102	60	•
CG56	III	20	32	1 x 50w	•	150 x 150	60	•
CG57	III	20	32	2 x 50w	•	150 x 225	88	•

Eco-friendly lamp options available

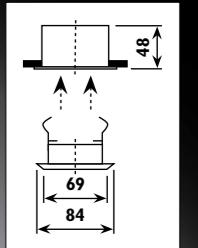

CB34

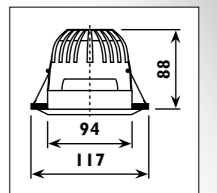

CB36



CB34 Steel and die-cast aluminium body with glass lens												
CB36 Die-cast aluminium body and heat sink, anodised aluminium reflector with glass lens												
Code	Class	IP	QC	Lamp/s	Transformer	Cutout	Clearance	Colour/s			Accessories	
				12v GU5,3 MR16	Required	(mm)	Height (mm)	Chrome	Satin chrome	White	Slab box & Slab lid	
CB34	III	30	22	50w	•	Ø 75	84	•	•	•	•	
CB36	III	30	32	50w	•	Ø 105	88	•	•	•	•	

Note: Products must be installed by a qualified Electrician



CB04

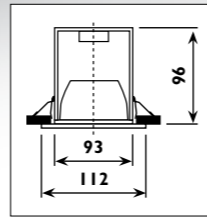

CB24

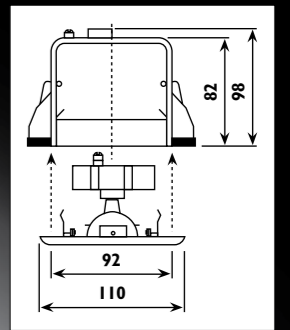

CB07

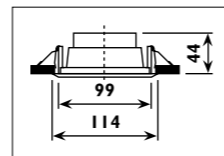

CK10

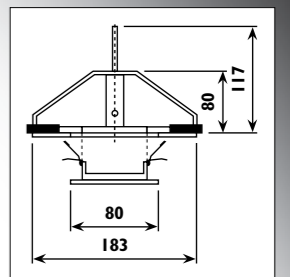



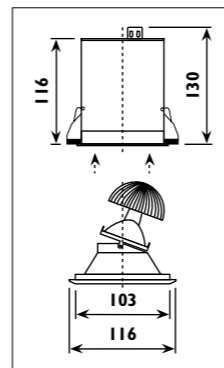



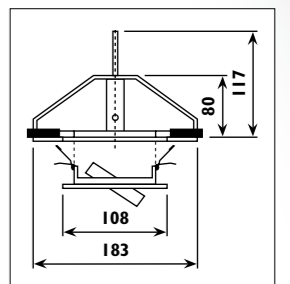









CB26



CK12



CB04 Steel body with anodised aluminium reflector											
CB07 Die-cast aluminium body and baffle											
CB26 Steel body, die-cast aluminium ring and heat sink with anodised aluminium reflector											
Code	Class	IP	QC	Lamp/s  12v GU5,3 MR16	Transformer  Required	Cutout  (mm)	Clearance  Height (mm)	Feature  Internal tilt	 White body/Black baffle	 White body/Silver reflector	Accessories  Slab box & Slab lid 
CB04	III	20	21	50w	•	Ø 100	96			•	•
CB07	III	20	32	50w	•	Ø 100	84		•		•
CB26	III	20	31	50w	•	Ø 104	130	30°		•	

CB24 Steel body, die-cast aluminium ring and heat sink										
CK10 - CK12 Steel body										
Code	Class	IP	QC	Lamp/s  12v GU5,3 MR16	Transformer  Required	Cutout  (mm)	Features  Tilt	Colour/s  Satin silver  White		Accessories  Slab box & Slab lid 
CB24	III	20	32	50w	•	Ø 98		•	•	•
CK10	III	20	21	50w	•	Ø 160			•	
CK12	III	20	21	50w	•	Ø 160	18°		•	



CB12

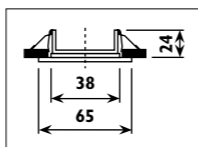

CD10

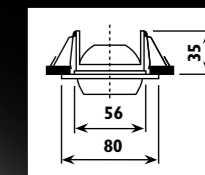

CD21

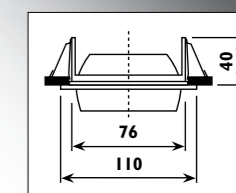

CB15

Packaged option for CB15 KIT



- CB15 KIT**  
 Containing:  
 • CB15  
 • Lamp  
 • Transformer  
 Colour/s  
 ■ Satin chrome  
 □ White

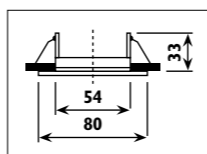

CC51

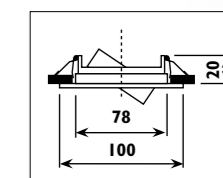

Steel body															
Code	Class	IP	QC	Lamp/s	Transformer	Cutout	Clearance	Colour/s						Accessories	
				12v GU4 MR11	12v GU5,3 MR16	Required	Height (mm)	Black	Chrome	Gold	Gunmetal	Satin chrome	White	Conversion bracket	Slab box & Slab lid
CB12	III	20	21	20w		•	Ø 45	56			•		•		•
CB15	III	20	21	50w		•	Ø 60	68	•	•	•	•	•	HG10 • HG11	•

Steel body																	
Code	Class	IP	QC	Lamp/s	Transformer	Cutout	Clearance	Features		Colour/s					Accessories		
				12v GU4 MR11	12v GU5,3 MR16	Required	(mm)	Height (mm)	Tilt	Rotate	Black	Chrome	Gold	Gunmetal	Satin chrome	White	Slab box & Slab lid
CD10	III	20	21	20w		•	Ø 65	43	30°	340°						•	•
CD21	III	20	21	50w		•	Ø 80	48	30°	340°		•	•	•	•	•	•
CC51	III	20	21	50w		•	Ø 85	65	18°		•	•	•	•	•	•	•



CB17

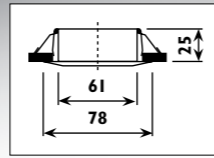

CC02

Optional range



BG72 • BG74 • BG75

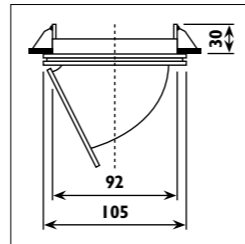

CC21 • CC24

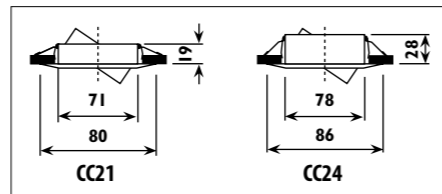

CC22

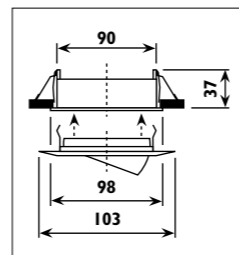

CB17 • CC02 • CC21 • CC24 Die-cast aluminium body																	
CC22 Die-cast aluminium body and steel housing																	
Code	Class	IP	QC	Lamp/s 12v GU5,3 MR16	Transformer Required	Cutout (mm)	Clearance Height (mm)	Features Tilt Rotate	Colour/s						Accessories		
									Chrome	Copper	Gold	Gunmetal	Satin brass	Satin chrome	White	Conversion bracket N ??	Slab box & Slab lid N ??
CB17	III	20	22	50w	•	Ø 62	64		•		•	•	•	•	•	HG10 • HG11	•
CC02	III	20	22	50w	•	Ø 98	79	80° 350°						•	•		•
CC21	III	20	22	50w	•	Ø 75	62	30°	•	•	•	•	•	•	•		•
CC22	III	20	22	50w	•	Ø 92	65	30° 340°						•	•		•
CC24	III	20	22	50w	•	Ø 80	64	30° 340°						•	•		•



CB18

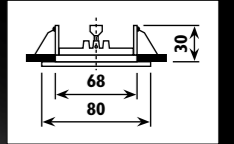

CC10

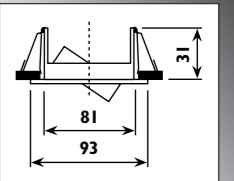

CC32

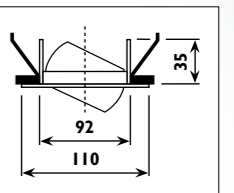

Die-cast aluminium body with twist off ring														
Code	Class	IP	QC	Lamp/s 12v GU5,3 MR16	Transformer Required	Cutout (mm)	Clearance Height (mm)	Feature Tilt	Colour/s				Accessories	
									Brass	Chrome	Satin chrome	White	Slab box & Slab lid N ??	Conversion bracket N ??
CB18	III	20	22	50w	•	Ø 70	63		•	•	•	•	•	HG10 • HG11
CC10	III	20	22	50w	•	Ø 85	60	20°	•	•	•	•	•	
CC32	III	20	22	50w	•	Ø 92	66	40°				•	•	

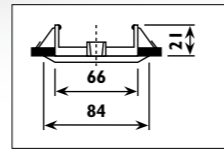

CB40

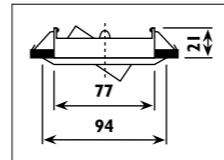

CC18

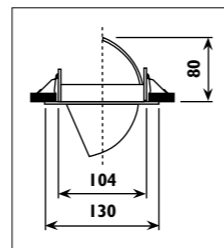

CC41

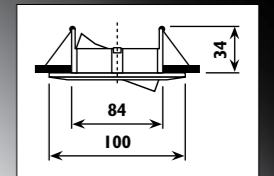

CC90

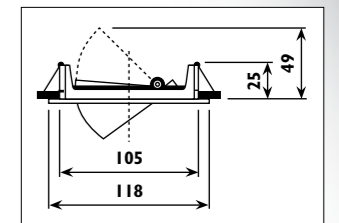

CC91

Die-cast aluminium body with twist off ring												
Code	Class	IP	QC	Lamp/s  12v GU5,3 MR16	Transformer  Required	Cutout  (mm)	Clearance  Height (mm)	Feature  Tilt  Rotate	Colour/s Brass Satin chrome White			Accessories  Slab box & Slab lid  Conversion bracket
CB40	III	20	22	50w	•	Ø 70	62			•	•	• HG10 • HG11
CC18	III	20	22	50w	•	Ø 85	63	32°		•	•	•
CC41	III	20	22	50w	•	Ø 110	80	72°	340°	•	•	•

Die-cast aluminium body with glass lens												
Code	Class	IP	QC	Lamp/s  12v GU5,3 MR16	Transformer  Required	Cutout  (mm)	Clearance  Height (mm)	Features  Tilt  Rotate	Colour/s Satin chrome White		Accessories  Slab box & Slab lid	
CC90	III	20	22	50w	•	Ø 85	70	30°		•	•	•
CC91	III	20	22	50w	•	Ø 105	72	40°	350°	•		•





CB44

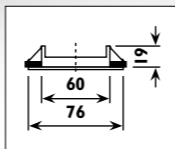

CC39

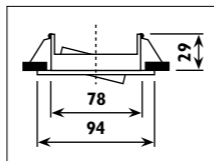

CC44

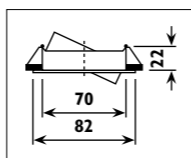

CB76

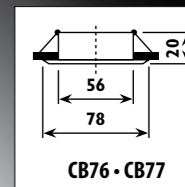

CB76 • CB77



CB77

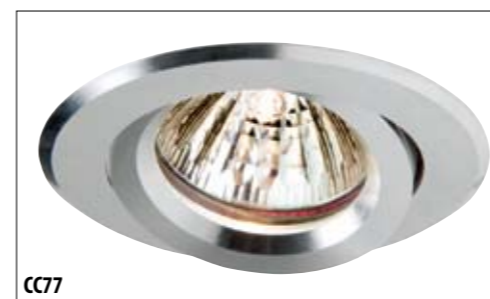

CC77

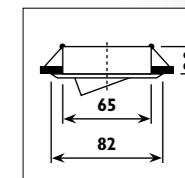

CC39 Die-cast aluminium body with twist-off ring

CB44 • CC44 Die-cast aluminium body

Code	Class	IP	QC	Lamp/s		Transformer	Cutout (mm)	Clearance Height (mm)	Features Tilt	Colour/s		Accessories	
				12v GU4 MR11	12v GU5,3 MR16					Satin chrome	White	Conversion bracket N ??	Slab box & Slab lid N ??
CB44	III	20	22	50w		•	Ø 63	60		•	•	HG10 • HG11	•
CC39	III	20	22	50w		•	Ø 82	65	20°	•			•
CC44	III	20	22	50w		•	Ø 72	60	35°	•	•		•

CNC aluminium body

Code	Class	IP	QC	Lamp/s		Transformer	Cutout (mm)	Clearance Height (mm)	Features Tilt	Colour/s Aluminium	Accessories	
				12v GU4 MR11							Required	(mm)
CB76	III	20	32	50w		•	Ø 60	70		•	HG10 • HG11	•
CB77	III	20	32	50w		•	Ø 60	70		•	HG10 • HG11	•
CC77	III	20	32	50w		•	Ø 67	70	43°	•		•





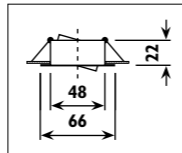



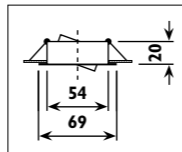

CC46



CC47



CC39 Die-cast aluminium body with twist-off ring										
CB44 • CC44 Die-cast aluminium body										
Code	Class	IP	QC	Lamp/s	Transformer	Cutout	Clearance	Features	Colour/s	Accessories
				 12v GU4 MR11	 Required	 (mm)	 Height (mm)	 Tilt	 Aluminium	 Slab box & Slab lid 
CC46	III	20	32	35w	•	Ø 55	70	45°	•	•
CC47	III	20	32	50w	•	Ø 60	70	45°	•	•



CB42

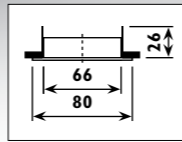

CC42

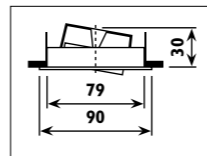

CC45

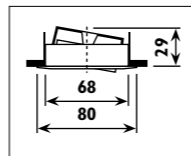

CB43

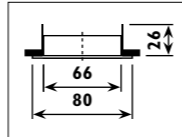

CC43

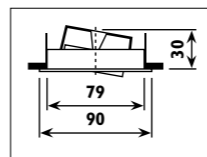

CNC aluminium body														
Code	Class	IP	QC	Lamp/s 12v GU5,3 MR16	Transformer Required	Cutout (mm)	Clearance Height (mm)	Features 	Colour/s Aluminium	Accessories				
										Inserts			Slab box & Slab lid N ??	Conversion bracket N ??
CB42	III	20	32	50w	•	Ø 70	62		•	HG80	HG81	HG82	•	HG10 • HG11
CC42	III	20	32	50w	•	Ø 82	60	18° 350°	•	HG85	HG86	HG87	•	
CC45	III	20	32	50w	•	Ø 72	55	18°	•	HG85	HG86	HG87	•	
CB43	III	20	32	50w	•	Ø 70	62		•	HG80	HG81	HG82	•	HG10 • HG11
CC43	III	20	32	50w	•	Ø 82	60	18° 350°	•	HG85	HG86	HG87	•	

Eco-friendly lamp options available

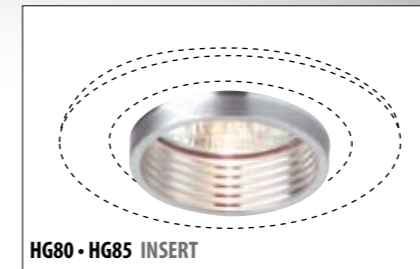

HG80 • HG85 INSERT

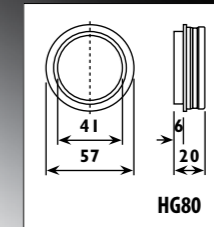

HG80

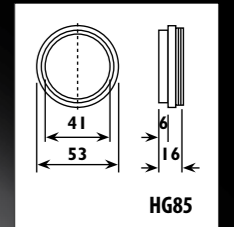

HG85

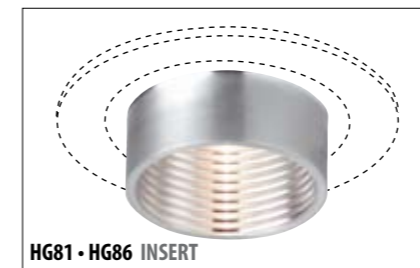

HG81 • HG86 INSERT

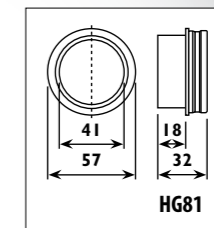

HG81

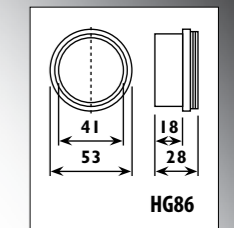

HG86



HG82 • HG87 INSERT

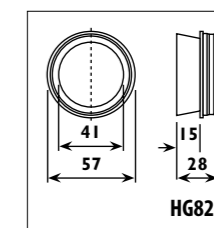

HG82

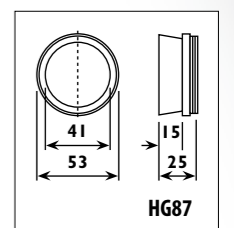

HG87

Optional inserts



CNC aluminium directional insert						
Code	HG80	HG81	HG82	HG85	HG86	HG87
Function	Anti-glare	Anti-glare	Anti-glare	Anti-glare	Anti-glare	Anti-glare
Accessories for Downlights	CB42 • CB43	CB42 • CB43	CB42 • CB43	CC42 • CC43 • CC45	CC42 • CC43 • CC45	CC42 • CC43 • CC45
Colour/s Aluminium	•	•	•	•	•	•

Note: Products must be installed by a qualified Electrician



CB71

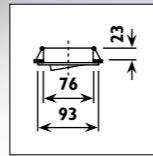

CB72

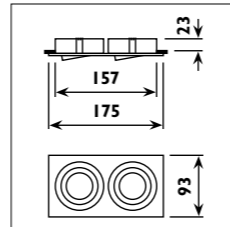

CB73

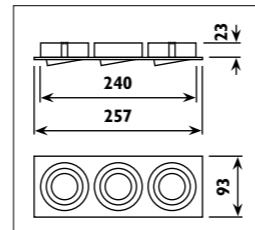

CB74

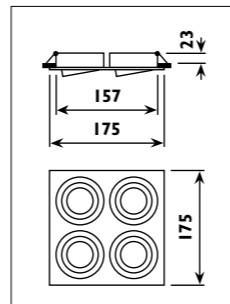
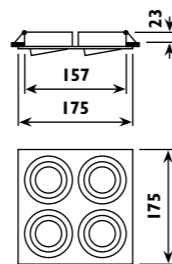

Range for CB71 • CB72 • CB73 • CB74



CB76 • CB77 • CC77

A ??

CNC aluminium body										
Code	Class	IP	QC	Lamp/s 12v GU5,3 MR16	Transformer Required	Cutout (mm)	Clearance Height (mm)	Features Tilt	Colour/s Aluminium	Accessories Slab box & Slab lid N ??
CB71	III	20	32	50w	•	Ø 80	70	43°	•	•
CB72	III	20	32	50w	•	80 x 157	70	43°	•	
CB73	III	20	32	50w	•	80 x 242	70	43°	•	
CB74	III	20	32	50w	•	160 x 163	70	43°	•	

Eco-friendly lamp options available



CB48

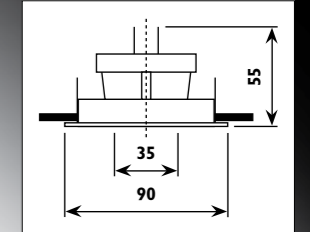

CC48

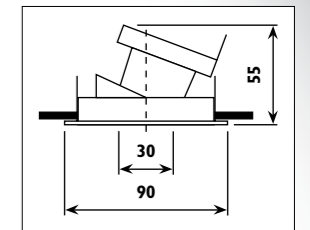

CNC aluminium body										
Code	Class	IP	QC	Lamp/s 12v GU5,3 MR16	Transformer Required	Cutout (mm)	Features Tilt	Colour/s Aluminium	Accessories Slab box & Slab lid N ??	
CB48	III	20	32	50w	•	Ø 82		•	•	
CC48	III	20	32	50w	•	Ø 82	40°	•	•	

Note: Products must be installed by a qualified Electrician



CB52

Range for CB52



BA03

B ??

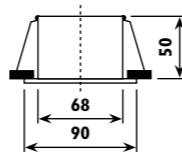

CB53

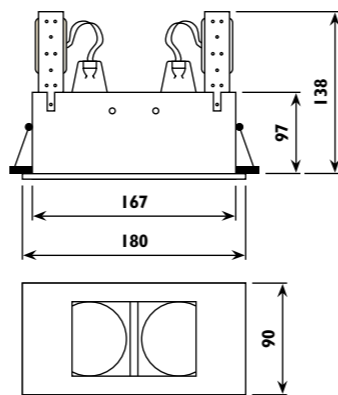

CB61

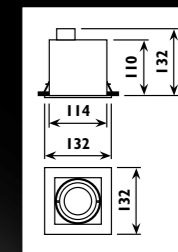

CB62

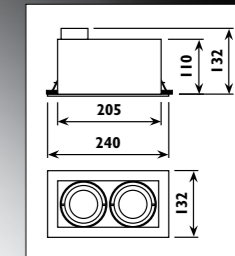

CB63

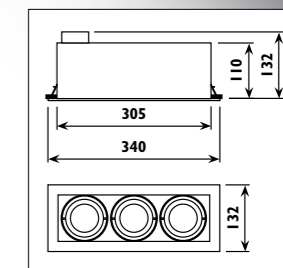

CB64

Range for CB61 • CB62 • CB63 • CB64

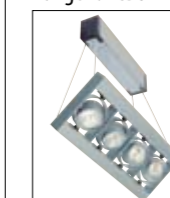

GX04RHX • GX04RX

GX04SX

C ??

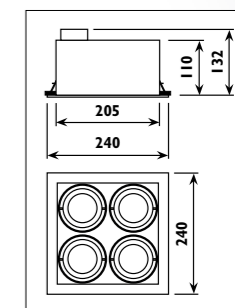

CB52 Steel body													
CB53 Steel and die-cast aluminium body													
Code	Class	IP	QC	Lamp/s	Transformer	Cutout	Clearance	Features	Colour/s				Accessories
				12v GU5,3 MR16	Required	(mm)	Height (mm)	Inner tilt	Satin chrome	Satin silver	White	White/black	Slab box & Slab lid
CB52	III	20	21	1 x 50w	•	80 x 80	83	30°	•	•	•	•	•
CB53	III	20	21	2 x 50w	•	70 x 173		45°					•

Steel and die-cast aluminium body										
Code	Class	IP	QC	Lamp/s	Transformer	Cutout	Features		Colour/s	Options
				12v GU5,3 MR16	Required	(mm)	Outer tilt	Inner tilt	Satin silver	230v versions
CB61	III	20	21	1 x 50w	•	115 x 115	90°	45°	•	AJ61
CB62	III	20	21	2 x 50w	•	115 x 220	90°	45°	•	AJ62
CB63	III	20	21	3 x 50w	•	115 x 325	90°	45°	•	AJ63
CB64	III	20	21	4 x 50w	•	215 x 215	90°	45°	•	AJ64



BK55

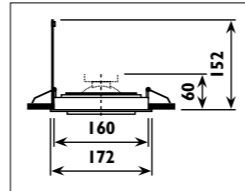

CK50

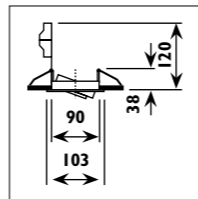

CJ01

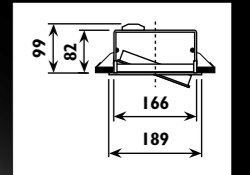

CJ31

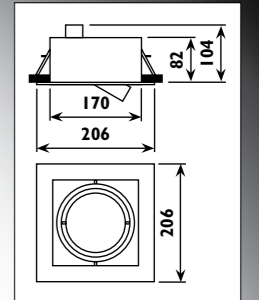

CJ32

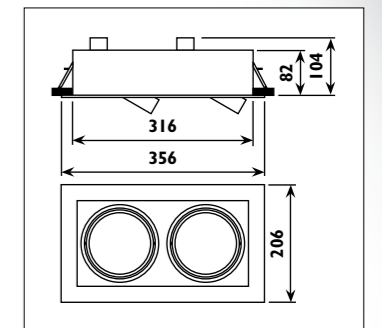

Die-cast aluminium body													
Code	Class	IP	QC	Lamp/s		Transformer	Cutout	Features		Colour/s			Accessories
				12v GU5,3 MR16	12v G53 AR111	Required	(mm)	Outer tilt	Inner tilt	Black	Satin silver	White	Slab box & Slab lid
BK55	III	20	32			•	Ø 163	30°	30°	•	•	•	
CK50	III	20	32	50w		•	Ø 92	30°	30°	•	•	•	•

Eco-friendly lamp options available

CJ01 Steel and die-cast aluminium body													
CJ31 - CJ32 Steel body													
Code	Class	IP	QC	Lamp/s	Transformer	Cutout	Features		Colour/s				
				12v G53 AR111	Required	(mm)	Outer tilt	Inner tilt	Satin silver	White			
CJ01	III	20	21	1 x 50w	•	Ø 175	58°	90°	•	•			
CJ31	III	20	21	1 x 50w	•	180 x 170	58°	90°	•				
CJ32	III	20	21	2 x 50w	•	324 x 170	58°	90°	•				

Note: Products must be installed by a qualified Electrician



CJ33

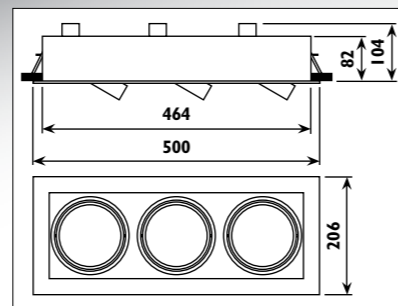

CJ21

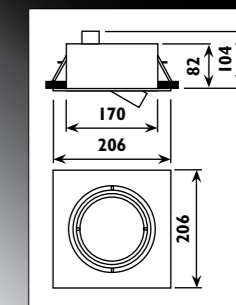

CJ34

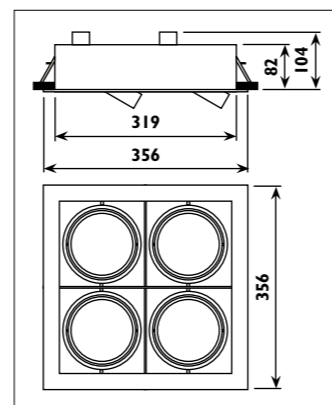

CJ22

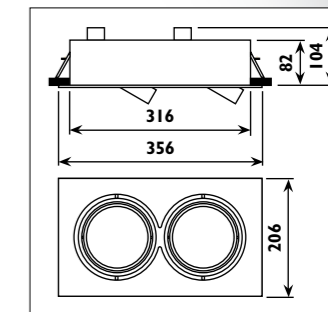

Range for CJ31 • CJ32 • CJ33 • CJ34



Steel body									
Code	Class	IP	QC	Lamp/s	Transformer	Cutout (mm)	Features		Colour/s
				12v G53 AR111	Required		Outer tilt	Inner tilt	Satin silver
CJ33	III	20	21	3 x 50w	•	482 x 170	58°	90°	•
CJ34	III	20	21	4 x 50w	•	330 x 330	58°	90°	•

Steel body									
Code	Class	IP	QC	Lamp/s	Transformer	Cutout (mm)	Features		Colour/s
				12v G53 AR111	Required		Outer tilt	Inner tilt	Satin silver
CJ21	III	20	21	1 x 50w	•	180 x 170	58°	90°	•
CJ22	III	20	21	2 x 50w	•	324 x 170	58°	90°	•



CJ23

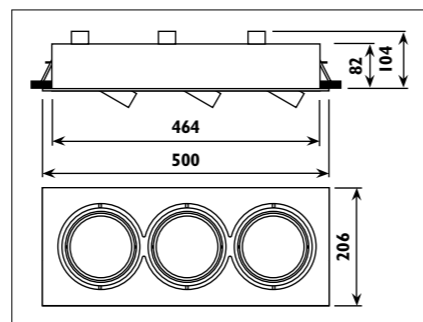

CJ24

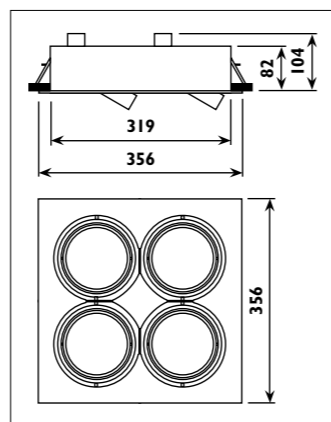

Steel body								
Code	Class	IP	QC	Lamp/s	Transformer	Cutout (mm)	Features	Colour/s
				12v G53 AR111	Required		Outer tilt Inner tilt	Satin silver
CJ23	III	20	21	3 x 50w	•	482 x 170	58° 90°	•
CJ24	III	20	21	4 x 50w	•	330 x 330	58° 90°	•