

RHEINZINK®

RHEINZINK® – CHECKLIST – SEAMING TECHNIQUES FOR PROFESSIONAL TRADES



Note: This is a partial checklist! Subject to modifications.

Bibliography

- RHEINZINK® – Applications in Architecture
- QUICK STEP – The RHEINZINK® Stepped Roof, Planning and Application
- RHEINZINK®-Standing Seam Technology, Planning and Application
- RHEINZINK®-Profile Technique for Façade Systems, Design and Application of Reveal Panels

© 2008 RHEINZINK GmbH & Co. KG

All rights reserved. Reprinting, photocopying – including excerpts – is not permitted without the written approval of RHEINZINK GmbH & Co. KG.

Note!

Dear Tradespeople!

By choosing RHEINZINK®, your customer has chosen a high-quality, durable material. The first step towards guaranteeing a long-term, maintenance-free service life is appropriate storage and processing for this type of quality material. Proper handling of RHEINZINK® material is a must!

This applies to transportation, storage and processing. Many things can be done incorrectly by the time installation is complete. This Checklist provides some insight into the most important rules, which must be complied with when working with RHEINZINK®. Please read these thoroughly and keep them close at hand.

Good luck!

Best regards
Your RHEINZINK-Team

PS: Of course, we'd be happy to provide you with more detailed information with respect to working with RHEINZINK®. For more information, please see www.rheinzink.com!

Legend



Checklist

Important points to note



Attention!

Warning with respect to processing errors

RHEINZINK® -Checklist

1. RHEINZINK® MATERIAL	Page
1.1 OVERVIEW	4-5
What is RHEINZINK®?	
What does RHEINZINK® look like?	
How is RHEINZINK® delivered?	
How is RHEINZINK® transported and stored properly?	
How is RHEINZINK® protected from corrosion?	
What is the life expectancy of RHEINZINK®?	
2. HOW TO!	Page
2.1 RHEINZINK®-ROOFING	
Ventilated roof structure, underlay	6
Double standing seam system, clips, square tiles, diamond tiles, flat lock tiles	7
2.2 RHEINZINK® – ROOFING DETAILS	
Eaves	8
Gable roof ridge, pent roof ridge	9
Valley, interior box gutters	10
Hip, verge, lateral wall connection	11
Pent roof, hipped gable roof, roof penetration, connections, expansion strip	12-13
Cross-seam	14
2.3 RHEINZINK®-FAÇADE CLADDING	
Ventilated substructure, Angled standing seam system, tile system	15
2.4 RHEINZINK® – DETAILS OF FAÇADE CLADDING	
Window opening, window sill flashing, lintel, jamb, corner of building, wall penetration	16
2.5 RHEINZINK®-ROOFING AND ACCESSORIES	
Lightning protection system, snow guard system, ice guards for snow guard system, support for roof steps, roof anchor	17
2.6 RHEINZINK®-JOINTING TECHNIQUES	
Soft soldering, adhesion	18
2.7 RHEINZINK®-ROOF DRAINAGE SYSTEMS AND COPING	
Roof drainage system, wall copings, connections, expansion elements	19

1.1 OVERVIEW



What is RHEINZINK®?

RHEINZINK® is titanium zinc according to DIN EN 988. The material has a high ductile yield and thus good processing capability. Precisely defined alloy components guarantee uniform colour for system products. RHEINZINK is a building metal with comparatively low CO₂-emissions during manufacturing and helps therewith protecting the climate.

RHEINZINK®-Material Properties

- Melting point: 418° C
- Specific weight: 7.2 g/cm³
- Expansion factor: 2.2 mm/m x 100 K
- Chemical composition/alloy components:
 - 99.995 % pure zinc
 - 0.08-1.00 % copper
 - 0.07-0.12 % titanium
- Surface: natural finish



RHEINZINK guarantees precise alloy proportions to ensure uniform weathering for the entire building. Do not combine zinc with that of other manufacturers.

RHEINZINK® Certification

- Natural material
- Minor energy consumption
- Durability
- An established cycle for valuable resources
- High rate of recycling > 95 %
- Shielded from electromagnetic radiation
- DIN EN ISO 9001:2000
- DIN EN ISO 14001

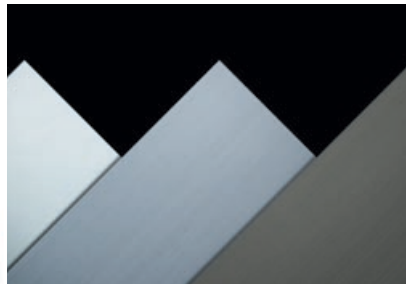

What does RHEINZINK® look like?

RHEINZINK®-Surfaces

- RHEINZINK®-bright rolled
- RHEINZINK®-"preweathered^{pro} blue-grey"
- RHEINZINK®-"preweathered^{pro} graphite-grey"

Properties of RHEINZINK®-bright rolled

- Forms a natural patina, which, depending on the location, orientation and roof pitch of the building, will appear different at different times.

Properties and features of RHEINZINK®-"preweathered^{pro}"

- Natural surface
- No coating
- Finished surface look
- Very little reflection
- Surface finish to reduce appearance of finger prints
- "Self-healing" (scratches become weathered over time)

Protective plastic film

To protect surfaces during transportation, storage and installation, RHEINZINK®-strips and panels can be covered with plastic film. The one-sided, self-adhesive plastic film is applied at the plant.



Following installation and, at the end of each working day, the plastic film must be removed!



How is RHEINZINK® delivered?

RHEINZINK®-strips (Coils)

- Standard width for roofing: 670 mm, 600 mm
- Standard width for façade cladding: 500 mm
- Weight: max. 1000 kg
- Small Coil - weight: max. 200 kg
- Inner diameter:
 - ≥ 500 kg = 508 mm
 - < 500 kg = 400 mm

RHEINZINK®-Sheets

- Standard width: 1000 mm (for "preweathered^{pro} graphite-grey surfaces": 700 mm)
- Standard thickness: 0.7 mm, 0.8 mm, 1.0 mm
- Standard length: 2000 mm, 3000 mm
- Pallet weight: max. 1000 kg



RHEINZINK®-strips and panels are shipped on leased pallets.

Markings – absolute certainty!

Each component comes with very specific identification, including material data and certification, which is stamped onto the product. This facilitates follow-up in the event of claims or disputes, even for components that have already been installed.

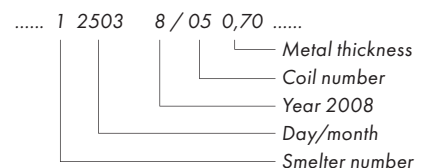
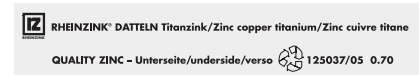



How is RHEINZINK® transported and stored properly?

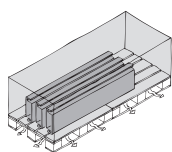
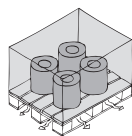
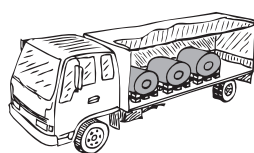

- Request a dry, well-ventilated room at the construction site, or store the material in containers.

What should you look for when working with the material?



- Do not knock over or throw coils
- Do not step or run on profiles
- Do not buckle profiles/panels or package them unprofessionally
- Do not place on moist floor

What can damage the RHEINZINK®-surface?

- Improper storage or transportation causes the formation of zinc hydroxide (durability is not affected)
- Sulfur deposits from oil heating causes brown discolouration (durability is not affected)
- Negative influences of other building materials (acidity, caustic solutions) or contact with other metals



External Influences



Oxidation - acidic corrosion

- Using seals made of non-protected bitumen or certain synthetic materials can lead to acidic erosion (low pH-value). RHEINZINK® should be protected with a full-surface coating (e.g. ENKE Metall Protect; sign maintenance agreements)
- Have the manufacturer of bituminous sealing strips sign off on the capabilities of the product when used together with RHEINZINK®



Contact corrosion with metals

- Avoid placing copper on top of zinc
- RHEINZINK® can be combined with aluminum, stainless steel, galvanized steel, as well as lead



Mortar corrosion

- Avoid contact with fresh mortar (high basic pH-value)
- Protective measures: full-surface coating



Corrosion in areas where wall termination profiles are used, e.g. on balconies

- Where wall termination profiles are installed, avoid constant moisture or acidic chemical components
- Full-surface coating on angled plates up to 2 cm above accessible sealant (e.g. with Enkryl plus Vlies von Enke)



Hot water corrosion

- Pay attention to design safety, e.g. minimum roof pitch, jointing technique, etc.
- Use the right underlay
- Pay attention to material expansion



Zinc hydroxide (surface rust)

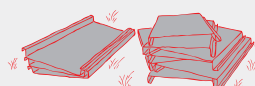

If zinc becomes moist while in storage or during transportation, the contact surfaces of materials stacked on top of each other begin to oxidize – and zinc hydroxide begins to form. This white, water-insoluble coating is very unattractive and, in most cases, cannot be removed. However, durability is not affected.



- No truck transport without tarpaulin
- Store dry and well ventilated
- Do not place on wet floors
- For work done by painters, plasters and other Trades after installation: temporary protective barriers (e.g. plastic sheets, tarps) must be removed at the end of each day!
- Do not stack panels on top of each other; transport panels in an upright position

What is the life expectancy of RHEINZINK®?

Life cycle assessments are using an life expectancy of RHEINZINK® unlike to coated materials of 75 years. (Institute TNO, NL).

HOW TO!

2.1 RHEINZINK®-ROOFING

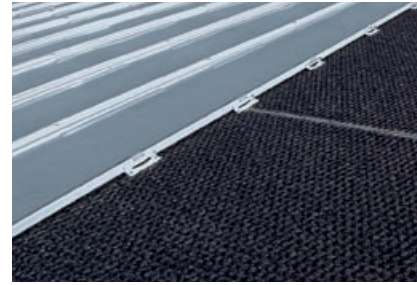

Ventilated roof structure 1
with non-ventilated supporting structure
and full rafter insulation

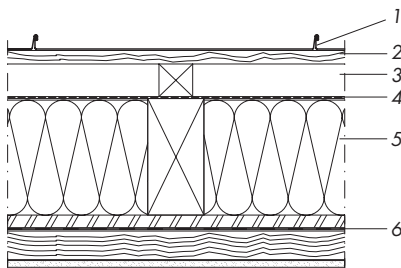

- 1 RHEINZINK®-Standing Seam System
- 2 Wooden sheathing 160 mm x 24 mm
- 3 Ventilated space (see Tab. 1)
- 4 Underlay as a sub-roof (function level)
- 5 Thermal insulation/rafters
- 6 Airtight layer with vapour barrier function (glue joints/edge connections and fasten directly to substructure)



- RHEINZINK® can be installed directly onto wooden sheathing.
- Simple fastening of clip
- Optimum ventilation technique (no arching of insulation)
- Optimum heat insulation technique using a wind barrier
- Protected from driving snow
- Protected against flying sparks and radiating heat (DIN EN 13501-5)

Ventilated roof structure 2
with ventilated supporting structure,
without full rafter insulation and with
a structured underlay

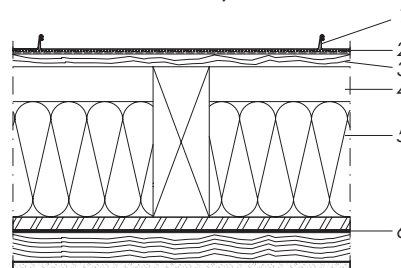

- 1 RHEINZINK®-Standing Seam System
- 2 Structured underlay- glass fibre bituminous felt V 13/Enka®-Vent 7008
- 3 Wooden sheathing 160 mm x 24 mm
- 4 Ventilated space (see Tab. 1)
- 5 Thermal insulation/rafters
- 6 Airtight layer with vapour barrier function (glue joints/edge connections and fasten directly to substructure)



- Do not use underlays which will trap water
- Avoid the use of double underlays
- Unfavourable ventilation technology (insulation arches = reduced net section)
- Thermal insulation technique is not optimum (no wind barrier)
- No protection from driving snow
- Protection against floating burning material and radiant heat

Underlay

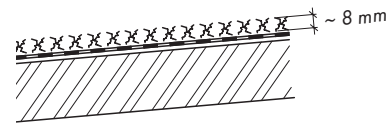

V13 and Enka®-Vent 7008



- Protects the structure during the construction phase
- Underlay for plywood, OSB-BFU-boards
- Function level or second drain-off level in the event of leakage, ice dam water, etc.
- For roof pitches of $\leq 15^\circ$: for underlays on site, e.g. V13, a structured braiding, e.g. Enka®-Vent 7008 must be installed
- For roof pitches $\geq 15^\circ \leq 70^\circ$ on wooden sheathing: underlay is not required
- For roof pitches $\geq 3^\circ \leq 70^\circ$ with large surface plywood boards: install structured underlay with felt
- All underlays can be used, depending on requirements (e.g. foil sheeting, bituminous sheeting, structured underlays)
- Underlays should not trap or absorb water

Roof pitch	Ventilated space Minimum height in mm	Intake and exhaust vent openings Min. net width in mm
$\geq 3^\circ$ to $\leq 15^\circ$	80	40
$> 15^\circ$	40	30

Tab. 1: Height of ventilated space in relation to roof pitch



For a full overview of roofing sub-structures, please request RHEINZINK®-Design Recommendations for Roof coverings!

2.1 RHEINZINK®-ROOFING

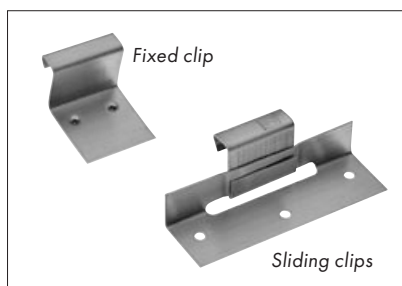

RHEINZINK®-Double standing seam system

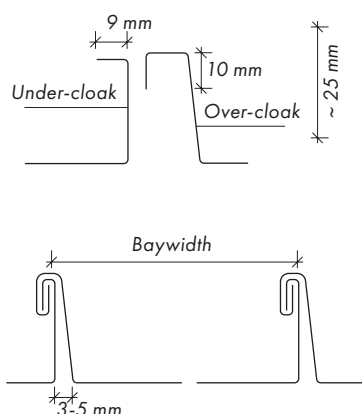

- Surfaces: bright rolled, "preweathered^{pro} blue-grey", "preweathered^{pro} graphite-grey"
- Metal thickness: 0.7 mm
- Coil width: 670 mm (600 mm)
- It is absolutely essential to comply with the seam dimensions specified, otherwise, problems will arise during profiling and mechanical seaming
- Coil width minus 70 mm (loss of seam) = ca. baywidth
- For roof pitches $\geq 3^\circ \leq 7^\circ$ with sealant tape
- If using a sealing strip, close the panel every ca. 0.5 m immediately following installation – otherwise the sealant tape will expand
- Processing temperature for seaming and forming involving impact: $\geq 10^\circ\text{C}$ metal temperature

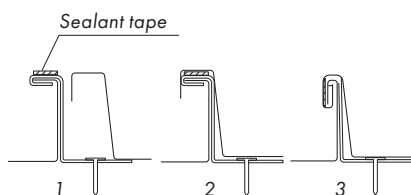

Clips, minimum number of clips

- The amount of clips depends on building height and panel width/material thickness according to DIN 1055 Part 4 design loads or prEC 1
- n = Min. no. of clips/m²
- s = max. distance of clips in mm

	Wall	Roof
Coil width in mm	500	670 ¹⁾
Panel width, ca., in mm	430	600
Material thickness in mm	0.8	0.7
min. number of clips ²⁾ per m ² / max clip intervals in mm	n/s	n/s
Wind loads (kN/m ²)		
≤ -0.3	4/500	4/500
≤ -0.6	4/500	4/500
≤ -0.9	4/500	4/500
≤ -1.2	4/500	4/500
≤ -1.5	6/350	6/300
≤ -1.8	7/300	7/300
≤ -2.1	8/250	9/250
≤ -2.4	8/250	9/250
≤ -2.7	10/200	10/200
≤ -3.0	11/200	11/150
≤ -3.3	11/200	11/150
≤ -3.6	13/150	13/150
≤ -3.9	13/150	
≤ -4.2	15/150	
≤ -4.5	15/150	
≤ -4.8	17/100	
≤ -5.1	17/100	

¹⁾ Coil widths for pent roofs and roofs in exposed areas ≤ 500 mm, material thickness 0.8 mm

²⁾ RHEINZINK®-clips

Arrangement of fixed clips

- Dependent on roof pitch
- 1-3 m for panel lengths of ≤ 10 m
- 3 m for panel lengths > 10 m
- Follow-up with designer/architect regarding windload requirements
- Use sliding clips for the rest of the roof surface

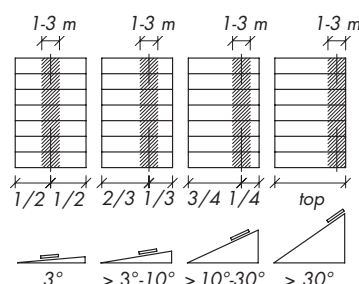

RHEINZINK®-Square tiles/diamond tiles

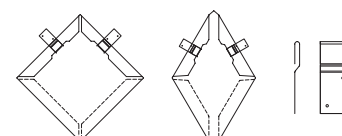

- Surfaces: bright rolled, "preweathered^{pro} blue-grey", "preweathered^{pro} graphite-grey" (except diamond tile)
- Recommended roof structure: ventilated roof design 1, see page 6
- Material thickness: 0.7 mm
- Standard size (standard tiles): 400 mm, 285 mm
- Roof pitch $\geq 25^\circ$



RHEINZINK®-Flat lock tiles



- Surfaces: bright rolled, "preweathered^{pro} blue-grey" and "preweathered^{pro} graphite-grey"
- Recommended roof structure: ventilated roof design 1
- Material thickness: 0.7, 0.8 and 1.0 mm
- Standard size: 333 mm x 600 mm and 400 mm x 800 mm (other sizes available)
- Roof pitch $\geq 25^\circ$

HOW TO!

2.2 RHEINZINK® – ROOFING DETAILS



Eaves on wooden sheathing without structured underlay

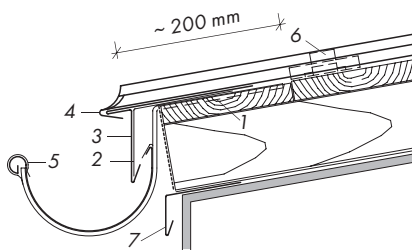

- 1 Fascia board, lowered
- 2 Continuous cleats made of galvanized steel 1.0 mm
- 3 Eaves flashing made of RHEINZINK®, 0.7 mm
- 4 Round eave termination with backfold
- 5 Gutter, gutter bracket, snap-lock bracket
- 6 Install clip adjacent to eaves flashing (ca. 200 mm)
- 7 Eaves profile for function level (sub-roof)



- Roof pitch $\geq 3^\circ \leq 15^\circ$
- Lowered fascia board
- Gutter brackets, flush-mounted
- Galvanized continuous cleats 1.0 mm
- RHEINZINK®-eaves flashings 0.7 mm
- Panel backfold open
- Comply with expansion area
- Result: guaranteed water course at the edge of the eave; no standing water!



Eaves termination, standing round (favoured solution)



Eaves termination, standing diagonal



Eaves termination, standing straight (only recommended for areas where aesthetics are important)

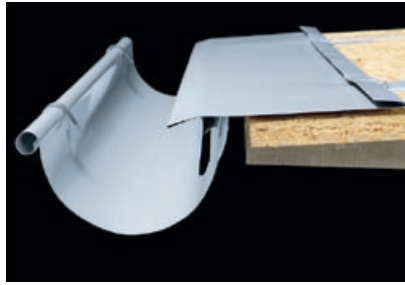

Detail optimization: Eaves Flashings

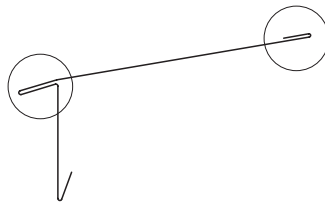

- Roof pitch $\geq 3^\circ \leq 10^\circ$
- Water check at the end of the eaves flashing = reduced capillary action
- Increase bend in eaves flashing from 5° to 10° in area where panel is being hung = improved drainage



Eaves termination with structured underlay

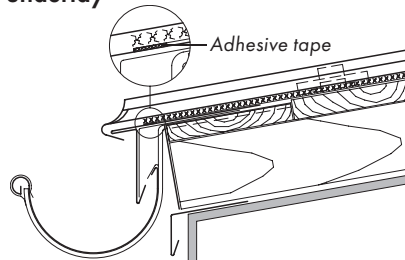

- Remove ca. 50 mm of the structured braiding
- Glue felt onto eaves flashing
- Watch for expansion area (do not place structured braiding over the front edge of the eaves flashing!)

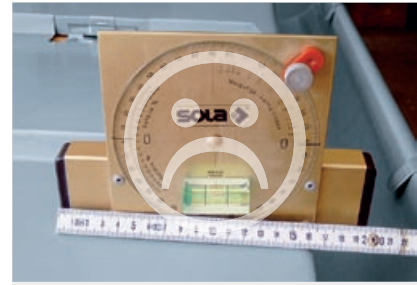

Eaves on wooden sheathing with negative detail designs

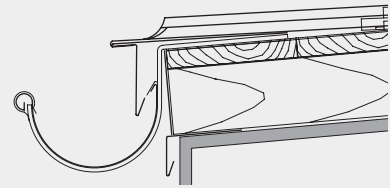

- Fascia board has not been lowered
- Gutter bracket has not been flush-mounted
- Eaves flashing without galvanized continuous cleat (unstable)
- Eaves termination too long
- Panel backfold has been pressed shut
- Insufficient room for expansion

Result:

- "leaky eave" because the roof pitch has been reduced to $\leq 3^\circ$ at the edge of the drainage area due to the poor detail solutions
- Capillary penetration as a result of an extremely flat pitch (unfavourable drainage conditions)
- Standing water (puddle formation) leads to dust deposits
- Lack of expansion area; panels arch as they contract during low temperatures = potential counter-incline

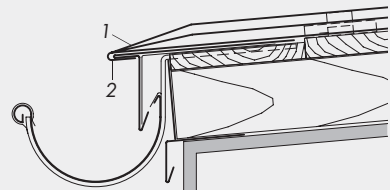

Re 1: Folded over eave design = potential stress fractures

Re 2: Thermal expansion (contraction of panels) not possible = dents or stress fractures

2.2 RHEINZINK® – ROOFING DETAILS



Ridge for a vented gable roof – high design with ventilation cross-sections

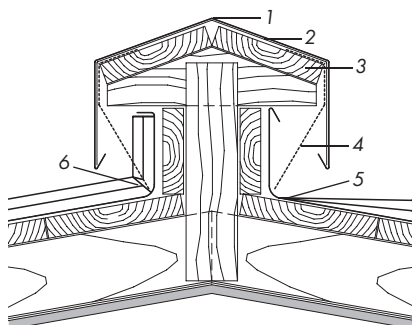

- 1 RHEINZINK®-Coping
- 2 Continuous cleat made of galvanized steel 1.0 mm
- 3 Wooden sheathing 160 mm x 24 mm
- 4 Perforated sheet acts as protection from blowing snow
- 5 Panel termination – turned down seam
- 6 Panel termination – pinched seam



- Wooden substructure
- Set-up height of panel, per roof pitch ≥ 150 mm
- Upper termination with water check
- Design of panel termination: turned down seam or pinched seam (in order to avoid tearing the material, do not set the turned down seam on anything with a sharp-edge)
- Watch for size of intake and exhaust vent openings
- Provide expansion area for panels
- With no function level or sub-roof, only a restricted solution for blowing snow is possible



Gable roof ridge with wooden battens

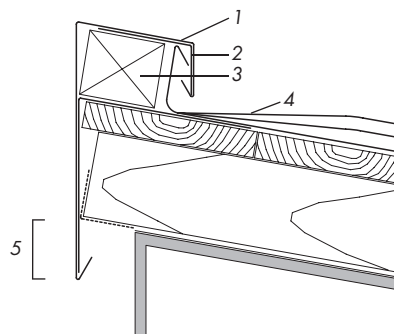

- 1 RHEINZINK®-Coping
- 2 1.0 mm continuous cleats made of galvanized steel
- 3 Wooden batten ≥ 60 mm
- 4 Panel termination – turned down seam
- 5 Overlap façade depending on height of building ≥ 50 mm ≤ 100 mm



- Overlap of RHEINZINK®-coping on the façade, depending on height of building ≥ 50 mm ≤ 100 mm
- Design of panel termination: turned down seam with connection height of ≥ 60 mm; proper connecting height for expansion strip is ≥ 40 mm to accommodate thermal expansion of panel
- Upper termination complete with water check
- Design expansion area for panel ≥ 15 mm

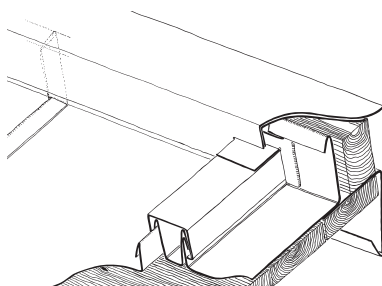

Expansion strip on gable roof ridge with wooden batten



Gable roof ridge – eave termination

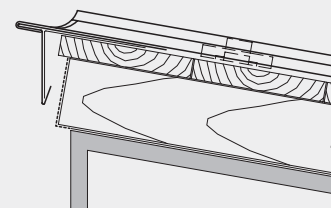

- Non-waterproof termination due to lack of folded-up area on panel
- Water overrun at edge of ridge
- Eaves termination is too long and no expansion area = potential leaking



Gable roof ridge without expansion area and insufficient installation height

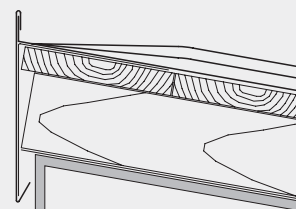

- Edges of turned down seam are too sharp = pinched material
- No water check
- Insufficient installation height
- No expansion area = dents, stress fractures, etc.

HOW TO!

2.2 RHEINZINK® – ROOFING DETAILS



Valley gutter recessed on structured mat

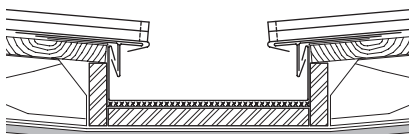

- For roof pitch of $\leq 10^\circ$
- Opening ≥ 150 mm
- Height of valley ≥ 60 mm
- Valley to drain into the roof gutter at the eave
- Set up snow guard system; additional waterproofing of roofs on wooden sheathing ca. 50 cm wide
- Design cross-vent in valley!



Valley with a single seam and soldered continuous cleat

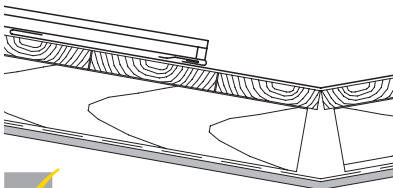

- For a roof pitch of $> 10^\circ$
- Girth ≥ 800 mm
- Soldered cleat cut length ≤ 80 mm, solder with panel
- Profile joints for valley pitch of $\leq 10^\circ$, solder with expansion elements
- Development of soldered cleat (s. page 14)
- Design cross-vent in valley!



Valley with a single seam

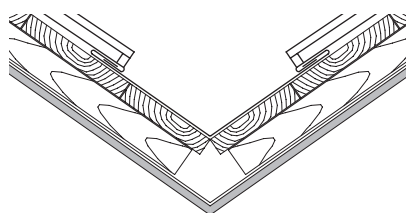

- For roof pitch of $\geq 25^\circ$ (35° *)
- Designed with a water check, 50 mm wide
- Girth ≥ 400 mm
- Profile joint designed as a single seam; overlap with feather edging or solder with expansion elements
- Design cross-vent in valley!

* in areas with heavy snowfall

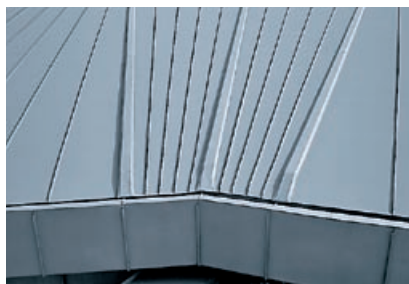

Valley by using tapered panels

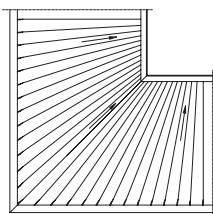

- For roof pitches of $\geq 5^\circ$ to $\leq 10^\circ$
- Panel width eave min. 100 mm
- Expensive/difficult with panels that are 6 m and longer due to the diagonal cut of the strips and creating the seam using tapered panels
- A better solution: a recessed valley gutter/channel



Seamed valley

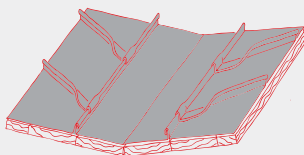

- Only valley lengths up to max. 3 m
- Roof and valley panels are seamed together. Stress fractures occur as a result of varying thermal expansion
- Intersections are difficult to design and realize (material cut-outs etc.)



Interior box gutter with lined overflow gutter

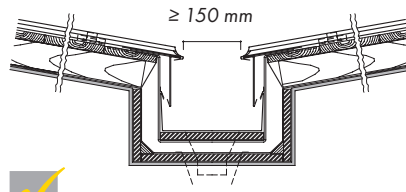

- Design overflows: design according to size of gutter (dimensioning)
- Position snow guard system
- Install expansion elements, clearance max. 6 m (s. Tab. page 19)
- Position gutter heaters
- Design roof drains for overflow gutter (take into account height-width dimensions)

2.2 RHEINZINK® – ROOFING DETAILS



Hip with batten and coping profile

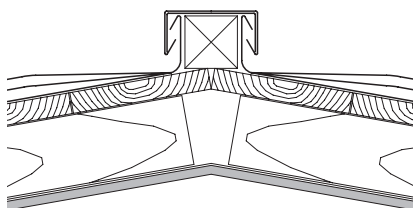

- Connection height ≥ 60 mm
- Design type: turned down seam
- Staggered seams are also possible
- Design and expansion technique benefits vis-à-vis "hip designed as a double standing seam"
- Coordinate connection height with verge and pent roof ridge with batten



Hip without batten and flashing

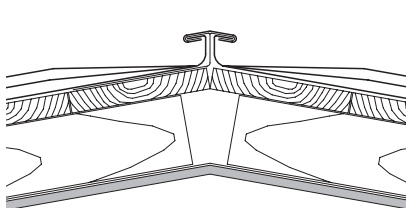

- Connection height ≥ 60 mm
- Alternative to "Hip with batten and coping profile"
- Design type: turned down seam
- Staggered seams are also possible
- Narrower solution is suited particularly for smaller components, e.g. dormers



Verge with Batten

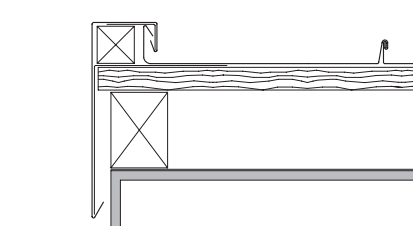

- Connection height ≥ 40 mm
- Design: lateral panel connection with water check
- Depending on height of building, overlapping width of fascia in the façade area is ≥ 50 mm or ≥ 100 mm
- Coordinate connection height: see hip and pent roof ridge detail



Hip or ridge designed as a double standing seam

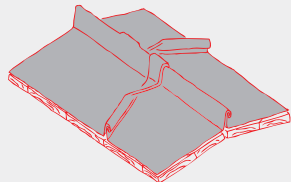

- Only for panel lengths of < 3 m, otherwise possibly problems with stress cracks due to thermal length expansion
- Seam gradient is not straight
- Seams must be staggered, cut outs are necessary, cracks are still possible

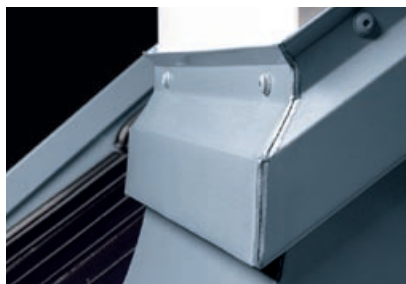

Lateral wall attachment

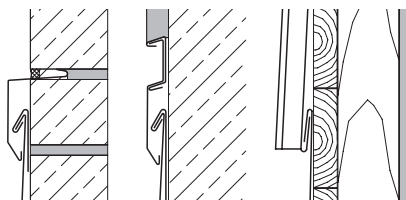

- Connection height ≥ 100 mm
- Upper termination with water check
- Coping using flashing strip or façade components
- Design variations on stucco wall, brick work or EIFS (exterior insulated finish system)



Verge for dormers, attics, fascias and small surfaces with short panels

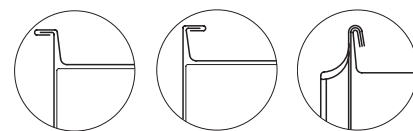

- Connection height ≥ 25 mm designed as a profile or standing seam fascia
- Suitable for round dormers and small surfaces with a roof pitch of $\geq 15^\circ$ (position sealing strip)
- Segmentation of fascia (round): work is done manually or products manufactured by Krehle (Germany) can be used

HOW TO!

2.2 RHEINZINK® – ROOFING DETAILS

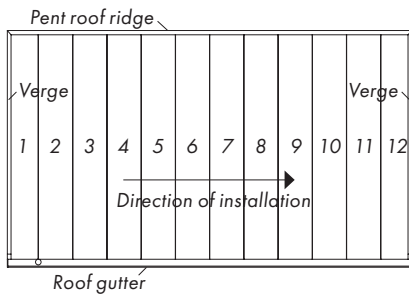

Installation sequence for pent roof without roof penetrations



- Roof pitch 7°
- Panel length 10 m (max. 16 m), coil width 670 mm
- Installation using Profimat/Falzomat

Design/steps:

- Symmetrical panel segmentation, verge panel 1 + 12, installation height ≥ 40 mm with water check (see page 11)
- Do not piece panels together
- Eave and pent roof ridge details (see page 8 + 9)
- Length to be added to panel: ca. 15 cm for eave, ca. 10 cm for ridge
- Check profile dimension
- Profile panel using Profimat (roll-former), under-cloak 9 mm, no plus tolerance
- Over-cloak (vertical leg) 10 mm, tolerance $\pm 0,5$ mm
- Note: if the over-cloak is too wide (e.g. 12 mm) seaming by machine is no longer possible
- Establish fixed clip area (each fixed clip is to be designed as illustrated below.)
- Fasteners to be distributed equally on cleat
- Distance between clips (see page 7)
- Each day, prior to leaving the construction site, the panels should be seamed shut or partially terminated like an angled seam (see page 7)

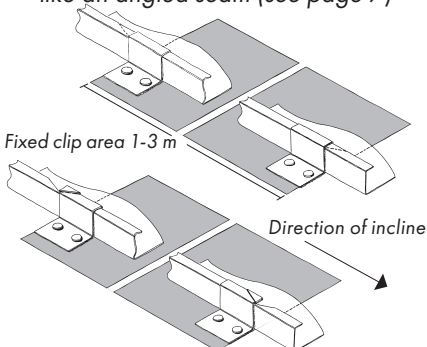

Installation of fixed clips

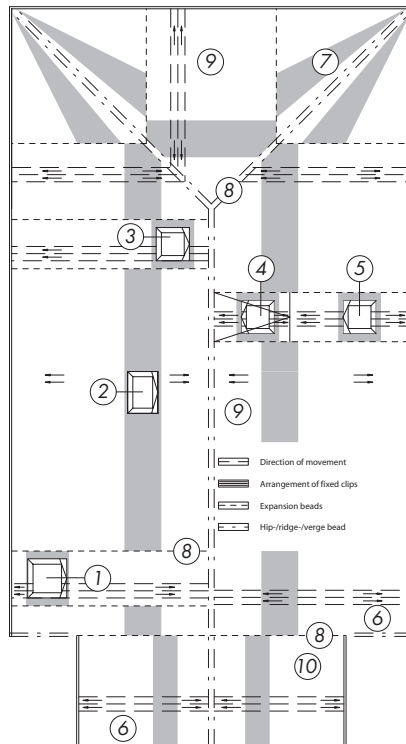

Installation sequence for a gabled roof with a hipped end and eaves off-set



- Panel length ≤ 10 m
- Roof pitch $\geq 3^\circ \leq 15^\circ$
- Roof penetrations on left side of roof: location of eave area (1), centre of roof (2) and ridge area (3)
- Roof penetrations on right side of roof: (4) + (5) one behind the other

Design/steps:

- Hip area: location of hip and expansion strips (8)
- Note direction of installation
- Ridge development (see page 9)
- Fixed clip (see page 7)
- Distance between clips (see page 7)
- Each day, prior to leaving the construction site, the panels should be seamed shut or partially terminated like an angled seam (see page 7)
- Penetration (2): within fixed clip area without expansion strip
- Penetration (1) + (3): outside fixed clip area (7) with expansion strips
- Penetration 4: located one behind the other; optimum design: elevated design of 10 cm (planning stage)
- Flashing: verge design (6) continuing as an expansion strip (8)

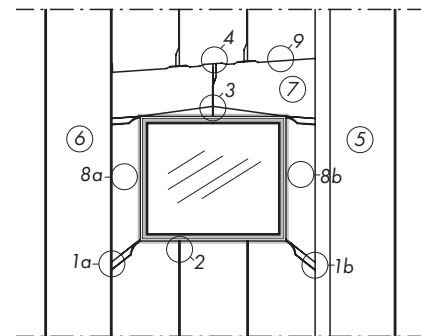

Roof penetration: back apron with tilting fillet and cross seam, front area with pinched seam, side flashing with expansion strip and double standing seam



Roof penetration: connections

- 1a: Rounded seam, $H = 1.50$ mm in linear seam (preferred option, if penetration is located within fixed clip area)
 - 1b: Rounded seam in expansion strip
 - 2: Pinched seam to front area
 - 3: Double pinched seam to back apron
 - 4: Intersection, linear seam in pinched seam (double seamed)
 - 5: Panel on expansion strip
 - 6: Panel on linear seam
 - 7: Back apron with tilted fillet
 - 8a: Side flashing on linear seam
 - 8b: Side flashing on expansion strip- width ≥ 20 cm (8a and b)
 - 9: Cross joint panel/back apron: double seamed with sealant tape running diagonally
- Note: For roof pitches starting at $\geq 10^\circ$, a cross joint – single seam with soldered cleat (see page 14) is preferred!**

2.2 RHEINZINK® – ROOFING DETAILS



Roof penetration
Details: proper seaming technique design (drawing – see page 12)



- Details should be designed exclusively using a seaming technique!
- Do not solder seam terminations with panel surfaces
- Do not place any ventilators or other penetrations in the linear seam
- Do not fasten any safety hooks directly onto the panel surface
- During installation, please observe the following sequence: front, side, back apron



Pinched seam on roof penetration (2)
Apron area



Double pinched seam in cross joint (3)
Back apron



Expansion bead with wood or metal



Expansion strips

- To ensure lengthwise panel expansion where roof penetrations are located outside areas with fixed clips
- If temperatures (metal temperatures) are < 10° C, seam termination details should always be heated using hot air



Expansion strip with wood



Expansion strip with metal bracket



Rounded seam connection (1a)
Upstand ≥ 150 mm with water check, pinched seam round seamed to double standing seam



Intersection (4)
Panel on cross joint, back apron

Result:
Detail design and implementation for roof penetrations requires expert craftsmanship.



Rounded seam connection (1b)
As 1a, but seamed to expansion strip

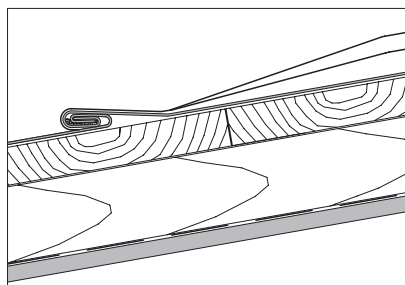

Cross-joint designed as double standing seam, horizontal (9)
with sealant tape

HOW TO!

2.2 RHEINZINK® – ROOFING DETAILS

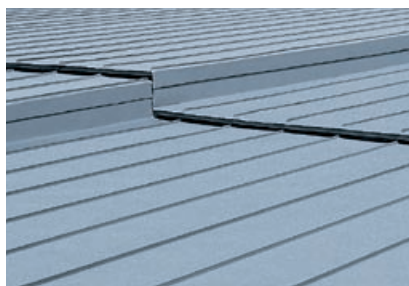

Cross joint designed as stepped falls

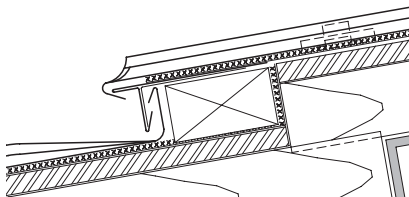

- Roof pitch $\leq 10^\circ$
- Panel length 10 to 16 m, installation using long sliding clips
- Stepped falls with turned down seam
Note: install wood structure (spacer blocks) later!
- Step height ≥ 60 mm
- Expansion area ≥ 15 mm

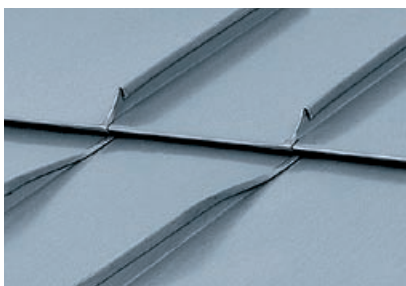

Cross joint designed as a single seam with soldered continuous cleats

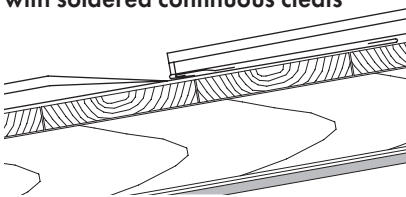

- Roof pitch $\geq 10^\circ < 25^\circ$ (35° *)
- Material thickness of soldered continuous cleats 0.80 mm
- Panel length max. 16 m
- Overlapping of panel ca. 250 mm
- Water check designed as a seam; do not notch or slit!
- Expansion area ≥ 15 mm



Cross joint designed as a single seam

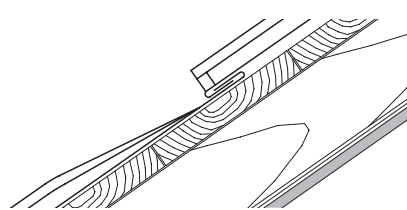

- Roof pitch $\geq 25^\circ$ (35° *)
- For double and angled standing seam system
- Overlap panel 50 mm per panel length
- Expansion area = 10 mm

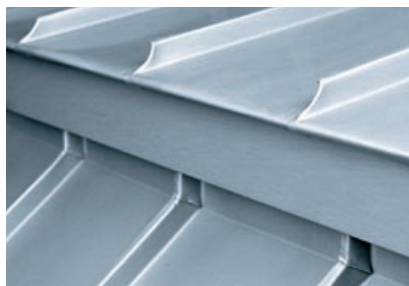

Stepped falls with pinched seam

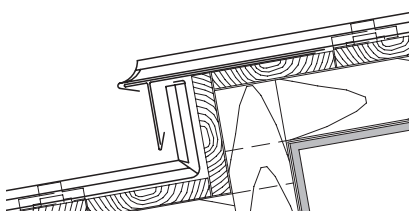

- Detail design of upper panel (see page 8, eave detail without structured underlay)
- Step height ≥ 80 mm



Detail optimization: soldered continuous cleats

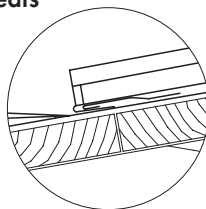

- Soldered continuous cleats with back-fold for panel hook-in (more stability)
- Material thickness 1.0 mm
- Length ≥ 2 m ≤ 3 m, Profile joint
- Overlap, do not solder
- Solder to panel



Seam in seam cross joint for angled standing seam system

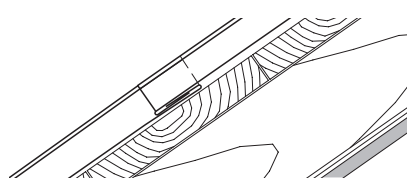

- Roof pitch $> 25^\circ$ (35° *)
- **Only for angled standing seam system!**
- Panel length ≤ 6 m
- Overlap area must accommodate thermal linear expansion of panel in the seamed area as well

* in areas with heavy snowfall

2.3 RHEINZINK®-FAÇADE CLADDING

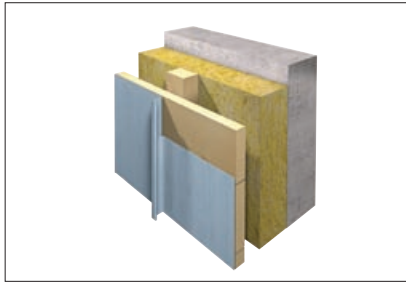

Ventilated substructure 1
Wood design

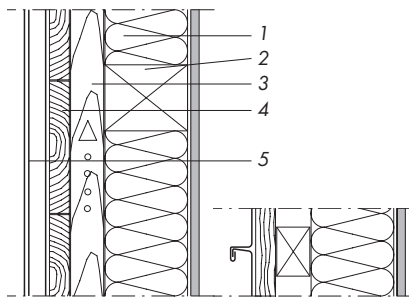

- 1 Thermal insulation
- 2 Wooden batten
- 3 Ventilation space
- 4 Wooden sheathing
- 5 Angled standing seam system

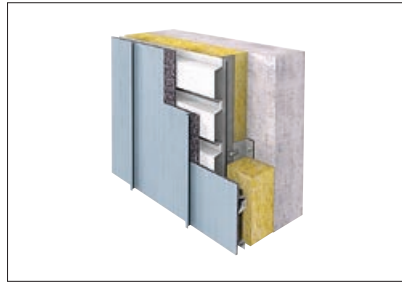

Ventilated substructure 2
Metal Design

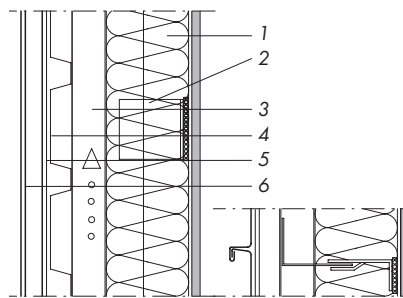

- 1 Thermal insulation
- 2 Bracket system made of metal with thermostop
- 3 Ventilation space
- 4 Trapezoidal profile
- 5 Underlay (buffer)
- 6 Angled standing seam system



RHEINZINK®-Angled Standing Seam System

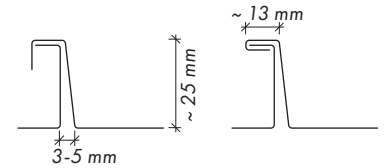

- Surfaces: "preweathered^{PRO} blue-grey" and "preweathered^{PRO} graphite-grey"
- Coil width: 500 mm
- Material thickness: 0.8 mm
- Optimum aesthetics when using sheets
- Always produce wall surfaces from the same batch in order to avoid colour discrepancies

- Sheet material preferred
- Angled standing seam system 500 mm x 0.8 mm
- Panel length ≤ 6 m (handling)
- Always fabricate panels and adapter panels from the same batch (colour consistency!)
- Panel fastening – see "Roofing – Double Standing Seam System"
- Wooden sheathing 100 mm x 24 mm or suitable OSB/BFU-boards, 22 mm
- Ventilation space ≥ 20 mm
- Thermal insulation (as per country standard)
- Windproofing is done on site!
- Fix panel on ridge, length of fixed clip area – 1 m

- Sheet material preferred
- Angled standing seam system 500 mm x 0.8 mm
- Panel length ≤ 6 m (handling)
- Adapter panels should always be made from the same batch (colour discrepancies!)
- For panel fastening, see "Roofing – Double Standing Seam System" – using suitable rivets/screws
- Use foil sheeting as a buffer
- Trapezoidal profile, galvanized steel with/without coating – type of profile depends on wind load
- Metal systems designed as sub-structures, including metal brackets, are used as fasteners
- Ventilation space ≥ 20 mm
- Thermal insulation
- Windproofing is done on site!
- Fix panel at ridge point, length of fixed clip area: 1 m



RHEINZINK®-Tile systems

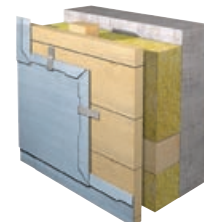

- Surfaces: "preweathered^{PRO} blue-grey" and "preweathered^{PRO} graphite-grey"
- Standard size: 333 mm x 600 mm und 400 mm x 800 mm (other sizes are available)
- Material thickness: 0,7, 0,8 and 1,0 mm

HOW TO!

2.4 RHEINZINK® – FAÇADE CLADDING DETAILS



Window opening with symmetrical segmentation

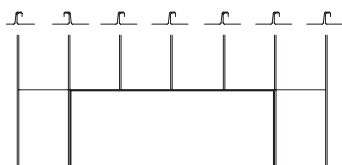

- ✓
- Panel width change up to ca. 50 mm is not discernable visually
- Seam should always be used at jamb locations
- If cross joints are used, these should be in the lintel area
- No soldering work around window sills. Traces left by soldering fluid cannot be repaired



Window sill coping

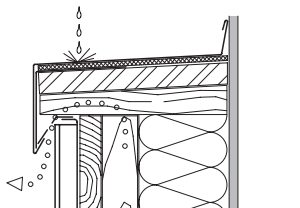

- ✓
- Coping should be full-surface bonded with Enkolit®, in order to prevent drumming sounds!
- Indirect fastening using continuous cleats is required if the leg height is ≥ 50 mm



Jamb

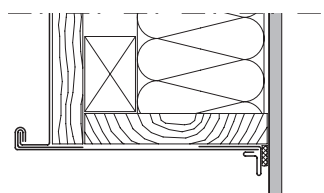

- ✓
- Angled standing seam designed at jamb connection
- Connect jamb to window frame using a plug-in pocket
- No direct fastening using screws or nails
- Do not solder window sill coping to jamb



Assymetrical window opening

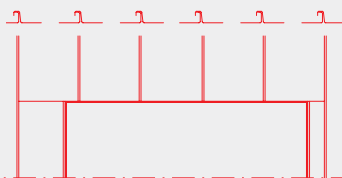

- !
- This is the result of unprofessional craftsmanship and lack of planning.
- A design using only one coil width is seldom possible.
- Change of seam is not designed.
- Soffit/lintel overlap is a sloppy detail



Lintel

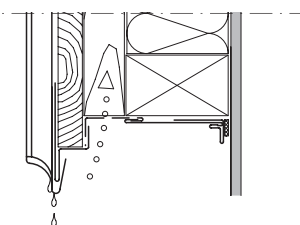

- ✓
- Air intake through perforated sheets or stamped openings in lintel profiles
- Lintel attached to window frame using plug-in pockets
- Surface connection flush with edge of eave

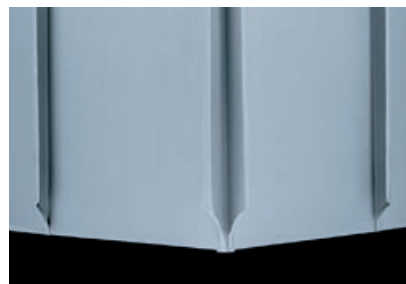

Corner of Building

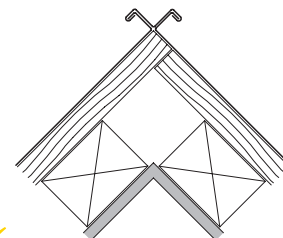

- ✓
- Symmetrical design
- Stable solution to prevent arching of corner panels

2.5 RHEINZINK® – ROOFING AND ACCESSORIES



Lightning Protection System
Eave design with flexible brackets

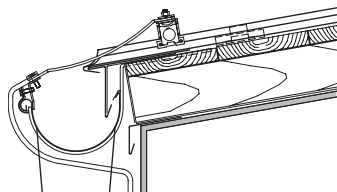

- Use lightning protection clamps made of aluminum wrought alloy (not copper)
- Flexible connecting wires can accommodate changes in panel length
- Arrester devices should be placed every ca. 20 m as per specifications
- Metal roof surfaces function as outer lightning protection, if there is no grounding.

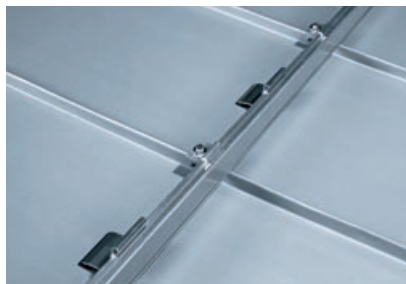

Snow guard system S5

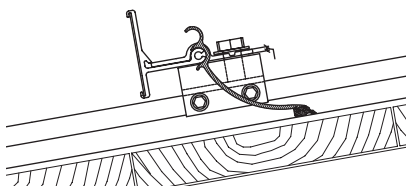

- Do not use galvanized components (risk of rust formation)
- Do not use snow guard clamps that are too narrow (cracks as a result of construction errors and installation in seam area)
- As a rule, install one snow guard clamp per seam



Retainers for roof steps

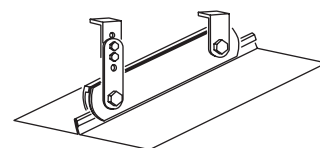

- Fasten clamping brackets to double standing seams
- Can be used for roof pitch of $\leq 40^\circ$



Lightning protection
Fix panel on point of eave = expansion cracks on panel



Ice guards for snow guard system



- Install ice guards to prevent sheet ice from falling
- Install 1 to 2 ice guards per panel, as required
- Do not use fasteners made of galvanized steel (risk of rust formation)

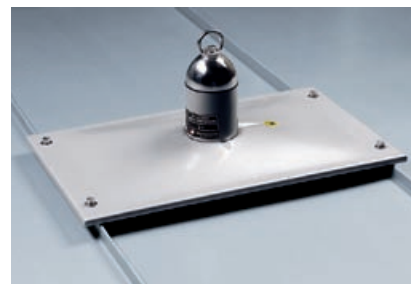

Latchways roof anchor Type 65618-00
Fall protection for craftsman working on standing seam roofs

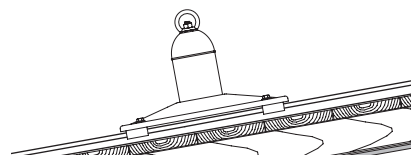

- Guides force directly into the construction without damaging the panel
- Fastened to the standing seam using S5 brackets – without penetration
- Coil in roof anchor dampens dynamic forces
- Allowed for eave and verge load according to DIN 4426



Snow guard system
The clamp has to allow thermal length expansion of the pipe.

HOW TO!

2.6 RHEINZINK®-JOINTING TECHNIQUES



Soft soldering

Soft soldering is an impervious solid connection performed in one operation.

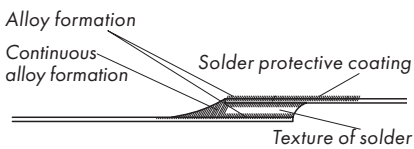

The following steps are to be taken into account to create a proper, professionally soldered seam:

Preparation:

- Clean dirty surfaces manually or with chemicals
- Sheet metal overlap ≥ 10 mm ≤ 15 mm
- Using a brush, apply flux full-surface and generously to the parts to be connected

Soldering process:

- Hammer bit > 350 g, preferably 500 g
- Working temperature ca. 250 °C
- Soldered gap $\leq 0,5$ mm, the narrower the soldered gap, the stronger the soldered seam
- Using the pre-tinned hammer edge, heat the parts to be joined to melting temperature
- The solder will be melted on the soldering bit in the amount required
- Soldering tin S-Pb60Sn40, low in antimony) penetrates the soldering gap with capillary action
- Pre-tin metal if metal thickness is > 0.8 mm

Finishing:

- Remove residual flux with a damp cloth = this is important aesthetically (see RHEINZINK®-Soldering Instructions)



Flux for soft soldering

Coat the RHEINZINK®-surface

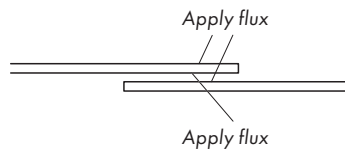

- Removes oxide residue and rolling emulsion
- Soldering flux is discharged
- Suitable for bright-rolled and "preweathered^{pro} blue-grey": liquid flux "ZD-pro" by Felder
- Suitable for "preweathered^{pro} graphite-grey": solvent + liquid flux "ZD-pro" (pre-clean manually or by using chemicals)



Sources of error when soft soldering



- Wrong soldering bit (pointed soldering bit)
- Overheated bit
- Soldering too quickly
- Insufficient weight = insufficient heat transfer
- Unsuitable flux (acid, etc.)
- Overlap of metal parts too big – from ≥ 40 mm ≤ 50 mm
- Soldering temperature too cold
- Do not leave profile joints for days without soldering (dirt reduces strength of soldered seam)



Proper handling of hammer bit

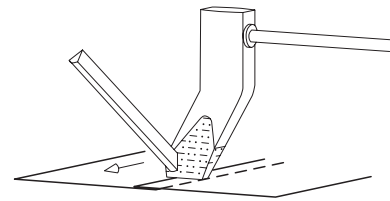

- Guide soldering iron, thoroughly solder overlap
- Heat to right temperature (ca. 250°C)
- Solder using even speed

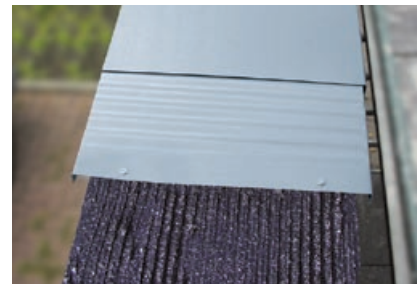

Adhesive bonding of copings



- Clean substructure
- Full-surface application of Enkolit® using a trowel
- Create joints using splicer plates or UDS connectors
- For vertical legs ≥ 50 mm, continuous cleats should be used

The permanently elastic bituminous adhesive, Enkolit®, has been used successfully in sheet metal technology for 40 years.

For proper usage, please see installation instructions provided by Enke for Enkolit®.

2.7 RHEINZINK® – ROOF DRAINAGE SYSTEMS AND COPING



**RHEINZINK®-
Roof Drainage System**

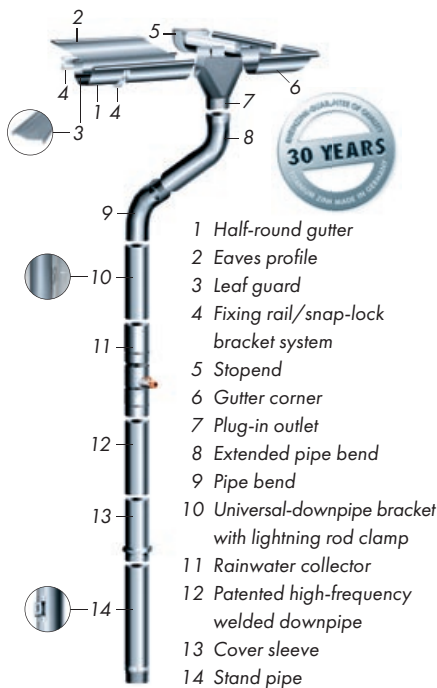

- Surfaces: bright rolled, "preweathered^{PRO} blue-grey", "preweathered^{PRO} graphite-grey"
- It's always a good fit: our complete roof drainage system consists of over 500 parts. Just ask!

**Gutters,
half-round or box-shaped**

- Material thickness for standard sizes ≤ 333 mm = min. 0.7 mm
- Material thickness for standard sizes ≥ 400 mm = min. 0.8 mm
- Standard sizes: 200 mm, 250 mm, 280 mm (only for half-round gutters), 333 mm, 400 mm, 500 mm
- Standard length: 3 m
- Fasten with suitable gutter brackets: RHEINZINK® coated or galvanized
- Fasten with proven snap-lock bracket system made of aluminum die casting
- Clearance of gutter bracket/snap-lock bracket or bracket retainer: ≥ 50 cm ≤ 90 cm
- Soft solder profile joint
- Expansion elements – see Table

Downpipe, round

- Downpipe according to DIN EN 612
- Material thickness for standard sizes $\leq 60/80$ mm = 0.65 mm
- Material thickness for standard sizes $\geq 100/120/150$ mm = 0.7 mm
- All pipe sizes are high frequency welded
- Standard length: 2 m or 3 m,
- Fasten with RHEINZINK®-pipe straps or RHEINZINK®-Universal-downpipe bracket

RHEINZINK®-Coping

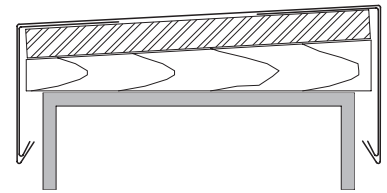

- Surfaces: bright-rolled, "preweathered^{PRO} blue-grey", "preweathered^{PRO} graphite-grey" (Profile up to max. 700 mm cut length)
- Material thickness: 0.8 mm (as a rule)
- Connect profile lengths properly and professionally
- Lateral inclination $\geq 3^\circ$
- Fasten indirectly using continuous cleats or through adhesive bonding using Enkolit®

Connections and Expansion Elements

- Soft Soldering and Expansion Elements (industrial)



- UDS-Connectors (industrial)



- Flat Expansion Joint (manually)



- Single Seam (manually)



Maximum distance for expansion elements

Gutters	Standard size/cut length	max. distance (m)* for expansion elements
Bracket-mounted gutters	≤ 500	15,0
Edge gutter	> 500	8,0
Interior box-type gutters	> 500	6,0
Shed roof gutters	> 800	6,0
Building profiles fastened indirectly	all standard sizes	8,0
Building profiles – glued in place	all standard sizes	6,0

* cut max. distance in front of corners and ends in half!

