



Section 7 Wooden Door Locks



Technical Features

- ☛ Robust construction for high level durability....
....and security
- ☛ Black powder coated steel case gives.....
.....exceptional corrosion resistance
- ☛ Single throw brass deadbolt with hardened steel..
.....rotating pins to prevent sawing.
- ☛ **Brass Latch, Pull and Twist for on site handing**
- ☛ 35° follower action for firm positive opening action,
....with firm follower spring for heavy duty handles.
- ☛ Suitable for Large Oval cylinders as well
- ☛ Separate forend in stainless steel or brass,
.....to conceal all fixings.

Included

- Flat strike, stainless steel or brass.
- Fixing screws for lock and striker

Specification

- **Bolt Tested:**
 - 500 kg side push resistant
 - 400 kg front push resistant
- **Durability Tested:**
 - 200 000 cycles 120N load ..
.. on the latch
- **Door Suitability**
 - up to 200kg doors, 15N max
...closing force.
- **Corrosion Resistance: F**
 - High Corrosion Resistant
 - 96 hour salt spray test



Item	Description	Faceplate	Throws	Type	Backset	Finish	Price without Cylinder
	☛ Dead lock version						
	<ul style="list-style-type: none"> - Brass face plate and brass plated strike - Stainless Steel face plate and strike 	25	1	55210	57	00	•
	☛ Latch and dead bolt						
	<ul style="list-style-type: none"> • Brass Latch, Pull and Twist for on site handing - Brass face plate and brass plated strike - Stainless Steel face plate and strike 	25	1	55220	57	00	•
	☛ Brass Rebate Kit for 55210, 55220						
	<ul style="list-style-type: none"> • Satin Brass • Satin Nickel Plated 			552RB 552RB		00 12	• •

LATCH LOCK ONLY

Legge



☛ **Brass Latch only**

- Face plate and strike Nickel Plated

22

L3709

60

12

•

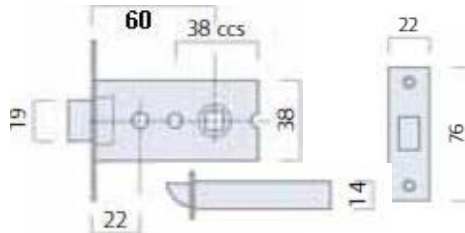



SASH LOCKS – NIGHT LATCH VERSION





Item	Description	Faceplate	Throws	Type	Backset	Finish	Price without Cylinder
 	<p>Latch only- night latch version</p> <ul style="list-style-type: none"> • Anti-thrust dead locking latch • Hold open catch keeps latch withdrawn • Recommended: Half handle set inside, or with outside... ..handle fixed. 						
	<ul style="list-style-type: none"> – Brass face plate and brass plated strike 	25	1	55250	57	00	•
	<ul style="list-style-type: none"> – Stainless Steel face plate and grey painted strike 	25	1	55250	57	20	•
	<p>Latch only as above - without hold open</p> <ul style="list-style-type: none"> – Stainless Steel face plate and grey painted strike (Supplied with 379N panic device) 	25	1	55250P	57	20	•

SASH LOCKS – 5 LEVER "500 KEY DIFFERS"

Item	Description	Faceplate	Throws	Type	Backset	Finish	Price
 	<p>Technical Features</p> <ul style="list-style-type: none"> • Yellow powder coated steel case • 5 brass close gate levers with anti-pick device. • Brass Latch, Pull and Twist for on site handing • Brass deadbolt with 2 hardened steel anti-saw inserts. • 2 Plated keys unnumbered 						
	<ul style="list-style-type: none"> – Brass face plate and brass plated strike 	25	1	52765	57	00	•
	<ul style="list-style-type: none"> – Stainless Steel face plate and strike 	25	1	52765	57	20	•
	<ul style="list-style-type: none"> – Stainless Steel face plate and strike- keyed alike 	25	1	52765K	57	20	•
	<p>Included</p> <ul style="list-style-type: none"> • Box strike, Satin S/S or Polished Brass. • Fixing screws for lock and striker. 			Keyed Alike 52765K			
				Key blank 02765	00	00	•

SASH LOCKS – 3 LEVER – HEAVY DUTY "100 KEY DIFFERS"

Item	Description	Faceplate	Throws	Type	Backset	Finish	Price
 	<p>Technical Features</p> <ul style="list-style-type: none"> • White powder coated steel case • 3 brass close gate levers with anti-pick device. • Brass Latch, Pull and Twist for on site handing • Brass deadbolt • 2 Plated keys unnumbered 						
	<ul style="list-style-type: none"> – Brass face plate and brass plated strike 	25	1	52763	57	00	•
	<ul style="list-style-type: none"> – Stainless Steel face plate and strike 	25	1	52763	57	20	•
	<ul style="list-style-type: none"> – Stainless Steel face plate and strike- keyed alike 	25	1	52763K	57	20	•
	<p>Included</p> <ul style="list-style-type: none"> • Flat strike, Satin S/S or Polished Brass. • Fixing screws for lock and striker. 			Keyed Alike 52763K			
				Key blank 02765	00	00	•



Technical Features

- Black painted steel case and cover
- Removeable brass faceplate and brass striker
- **Reversible** brass latch without opening lock.
- Brass double throw deadbolt

Operation

- From outside or inside: the latch is operated ...by key or handle. Deadbolt by key only

Finishes

- Satin Nickel plated – finish code "12"
- Satin Brass – finish code "00"



Included

- Strike
- Fixing screws for lock and striker

Certification

- This lock is certified according to EN 12209:03
- **Security grade 3: Bolt**
 - 500 kg side push resistant
 - 400 kg front push resistant
- **Durability grade X**
 - 200 000 cycles 120N load .. on the latch
- **Corrosion Resistance: C**
 - High Corrosion Resistant
- **Door Mass grade 7**
 - up to 100kg doors, max 15N ..max. closing force.



Item	Description	Faceplate	Throws	Type	Backset	Finish	Price including Cylinder	Price without Cylinder	
LATCHING VERSION									
 	<p>Latch Version</p> <ul style="list-style-type: none"> • Double throw deadbolt and latch. • Cylinder 0G300-07 • Strike 06102-13 	Satin Brass Finish							
		22	2	5C110	40	00	•	•	
		22	2	5C110	50	00	•	•	
		22	2	5C110	60	00	•	•	
	22	2	5C110	70	00	•	•		
	Satin Nickel Plated Finish								
	22	2	5C110	40	12	•	•		
	22	2	5C110	50	12	•	•		
	22	2	5C110	60	12	•	•		
	22	2	5C110	70	12	•	•		
		<p>Brass Rebate Kit</p> <ul style="list-style-type: none"> • Satin Brass • Brass Nickel plated finish 12. 			521RB	00		•	
						521RN	12		•
ROLLER BOLT VERSION									
	<p>Rollerbolt Version</p> <ul style="list-style-type: none"> • Double throw deadbolt and roller. • Cylinder 0G300-07 • Strike 06149.00. • Include rose set 06012 	Satin Brass Finish							
		22	2	5C120	40	00	•	•	
		22	2	5C120	50	00	•	•	
		22	2	5C120	60	00	•	•	
	22	2	5C120	70	00	•	•		
	Satin Nickel Plated Finish								
	22	2	5C120	40	12	•	•		
	22	2	5C120	50	12	•	•		
22	2	5C120	60	12	•	•			
22	2	5C120	70	12	•	•			



Technical Features

- Galvanised steel case and cover
- Removeable steel faceplate and steel striker
- **Reversible BICONICAL latch**
- Non handed – change latch without opening lock
- Brass or nickel plated steel double throw deadbolt
- ☞ *Round faceplate and strike upon request*

☞ **Operation**

- From outside or inside: the latch is operated ...by key or handle. Deadbolt by key only

☞ **Finishes**

- Nickel plated – finish code "12"
- Brass plated – finish code "00"



☞ **Included**

- Strike
- Fixing screws for lock and striker

Certification

- ☞ This lock is certified according to EN 12209:03
- **Security grade 3: Bolt**
 - 500 kg side push resistant
 - 400 kg front push resistant
- **Durability grade X**
 - 200 000 cycles 120N load on the latch
- **Corrosion Resistance: C**
 - High Corrosion Resistant
- **Door Mass grade 7**
 - up to 100kg doors, max 15N ..max. closing force.



Item	Description	Faceplate	Throws	Type	Backset	Finish	Price including Cylinder	Price without Cylinder
LATCHING VERSION								
 <p>Latch Version</p> <ul style="list-style-type: none"> • Double throw deadbolt and latch. • Cylinder 08010-07 • Strike 06102-13 <p>Latch Version for WC Indicator</p> <ul style="list-style-type: none"> • Single throw deadbolt and latch. • Use with WC Indicator:- 8mm spindle • Strike 06102-13 <p>Rebate Kit</p> <ul style="list-style-type: none"> • Steel satin brass plated • Satin stainless steel finish "20" 	Brass Plated Finish							
	22	2	5C611	40	00	•	•	
	22	2	5C611	50	00	•	•	
	22	2	5C611	60	00	•	•	
	22	2	5C611	70	00	•	•	
	Nickel Plated Finish							
	22	2	5C611	40	12	•	•	
	22	2	5C611	50	12	•	•	
	22	2	5C611	60	12	•	•	
	22	2	5C611	70	12	•	•	
	Brass Plated Finish							
	22	1	5C651	50	00		•	
22	1	5C651	60	00		•		
Nickel Plated Finish								
22	1	5C651	50	12		•		
22	1	5C651	60	12		•		
521BP					00		•	
521SS					20		•	
ROLLER BOLT VERSION								
 <p>Rollerbolt Version</p> <ul style="list-style-type: none"> • Double throw deadbolt and roller. • Cylinder 08010-07 • Strike 06149.00. • Include rose set 06012 	Brass Plated Finish							
	22	2	5C621	40	00	•	•	
	22	2	5C621	50	00	•	•	
	22	2	5C621	60	00	•	•	
	22	2	5C621	70	00	•	•	
	Nickel Plated Finish							
	22	2	5C621	40	12	•	•	
	22	2	5C621	50	12	•	•	
22	2	5C621	60	12	•	•		
22	2	5C621	70	12	•	•		



Technical features:

- "U" Shaped adjustable faceplate
22 x10mm in satin finished laquered brass,
2600mm long.
- Upper adjustment 650mm
- lower adjustment 35mm.
- Zinc plated steel case.
- Reversible nickel plated latch
- Nickel plated DOUBLE THROW deadbolt.

Supplied as standard:

- Striker and fixing screws
- Without cylinder.
- Instruction sheet

Hand:

0 = Non-handed

Description	Code	Backset	Finish	Price w/out Cylinder
<p>Channel 2600 x 22 x10mm</p> 				
<p>53131 -Top & Bottom - Locking features</p> <ul style="list-style-type: none"> • Latch-bolt and central dead-bolt. • Top and bottom extended bolts... ..integrally mounted on the face plate <p>Including :</p> <ul style="list-style-type: none"> • Central striker 06213-05 • 2 upper strikers 06292-00 and 06292-01 • Floor striker 06086-00 • Supplied without cylinder 	<p>Satin Brass Finish</p> <p>53131 45 00 •</p> <p>53131 50 00 •</p> <p>53131 60 00 •</p> <p>Nickel Plated Finish</p> <p>53131 45 12 •</p> <p>53131 50 12 •</p> <p>53131 60 12 •</p>			
<p>53135 -Side locking - Locking features</p> <ul style="list-style-type: none"> • Latch-bolt and central dead-bolt. • Top and bottom front dead-bolts operated.. ..by rods integrally mounted on the faceplate <p>Including :</p> <ul style="list-style-type: none"> • Central striker 06213-05 • 2 lateral strikers 06323-01 • Supplied without cylinder 	<p>Satin Brass Finish</p> <p>53135 45 00 •</p> <p>53135 50 00 •</p> <p>53135 60 00 •</p> <p>Nickel Plated Finish</p> <p>53135 45 12 •</p> <p>53135 50 12 •</p> <p>53135 60 12 •</p>			
<p>53137 -5 Locking points - Locking features</p> <ul style="list-style-type: none"> • Latch-bolt and central dead-bolt. • Top and bottom front dead-bolts operated.. ..by rods integrally mounted on the faceplate • Top and bottom extended bolts... ..integrally mounted on the face plate <p>Including :</p> <ul style="list-style-type: none"> • Central striker 06213-05 • 2 lateral strikers 06323-01 • 2 upper strikers 06292-00 and 06292-01 • Floor striker 06086-00 • Supplied without cylinder 	<p>Satin Brass Finish</p> <p>53137 45 00 •</p> <p>53137 50 00 •</p> <p>53137 60 00 •</p> <p>Nickel Plated Finish</p> <p>53137 45 12 •</p> <p>53137 50 12 •</p> <p>53137 60 12 •</p>			

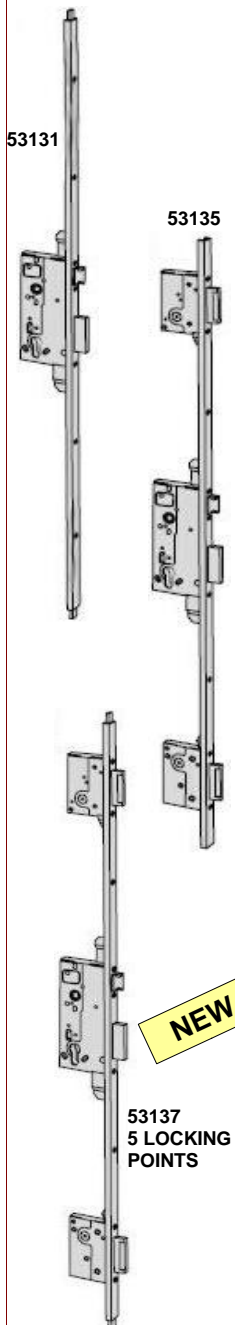

NEW

NEW

ROLLER BOLT VERSIONS

All Above are availbale in Roller Bolt Versions.
Specify "R" prefix , and state "Roller" on the Order
No Surcharge for this version.

Lead time: Nickel plated finish is made on demand and lead time is two weeks.





- Technical features:**
- Black painted steel case and cover.
 - Brass faceplate and strike
 - Double throw deadbolt made of brass.

- Supplied as standard:**
- Striker
 - Fixing screws for lock and striker
 - Cylinder fixing screw
 - Rose set

- Available finishes:**
- Satin nickel plated brass (fin.12)
 - Satin brass (fin.00)

Conforms to EN 12209:2003

- Complies with Durability Grade C - 50 000 test cycles.
- Complies with Door Mass Grade 7 - up to 100 kg door mass: 15N max closing force.

Type	Description	Throws	Code	Backset	Finish	Price including Cylinder	Price without Cylinder
 <p>Single throw deadbolt</p> <ul style="list-style-type: none"> • Strike 07032 • Cylinder 0G545-05 • Rose set 06012.00 	<p>*Available while stocks last</p>	1	52210*	25	00	•	•
		1	52210*	25	12	•	•
 <p>Double throw deadbolt</p> <ul style="list-style-type: none"> • Strike 07032 • Cylinder 0G545-05 • Rose set 06012.00 • Satin brass faceplate and strike finish 00. • Satin nickel plated finish 12. <p>Brass Rebate Kit</p> <ul style="list-style-type: none"> • Satin Brass • Nickel plated finish 12. <p><i>☞ Metal Weld-on Box for Metal Gates</i></p>		2	52310	40	00	•	•
	2	52310	40	12	•	•	
	2	52310	50	00	•	•	
	2	52310	50	12	•	•	
	2	52310	60	00	•	•	
	2	52310	60	12	•	•	
	2	52310	70	00	•	•	
	2	52310	70	12	•	•	
		523RB		00	•	•	
		523RN		12	•	•	
	523MBOX	60		•	•		

CYLINDER HOOK LOCKS – BRASS AND STEEL VERSIONS



- Technical features:**
- Zinc plated steel case and cover.
 - Brass faceplate and strike (series 45100).
 - Steel faceplate and strike (series 45110).
 - Passivated laminated steel hook.

- Available finishes:**
- Series 45100**
- Satin nickel plated brass (fin.12)
 - Satin brass (fin.00)
- Series 45110**
- Brass plated (fin.00)
 - Nickel plated (fin.12)

- Supplied as standard:**
- Striker, Rose set with screws.
 - Fixing screws for lock and striker
 - Cylinder fixing screw

45110 Conforms to EN 12209:2003

- Complies with Durability Grade C - 50 000 test cycles.
- Complies with Door Mass Grade 8 - up to 200 kg door mass: 15N max closing force.

Type	Description	Code	Backset	Finish	Price including Cylinder	Price without Cylinder
 <p>Brass faceplate and striker</p> <ul style="list-style-type: none"> • Strike 07028.10 • Cylinder 0G545-05 • Rose set 06012.00 • Satin brass faceplate and strike finish "00". • Satin nickel plated finish "12". <p>Steel faceplate and striker</p> <ul style="list-style-type: none"> • Strike 07028 • Cylinder 0G545-05 • Rose set 06012.00 • Brass plated faceplate and strike finish "00". • Satin nickel plated finish "12". <p><i>☞ Version with Steel Guide pin</i></p>		45100	35	00	•	•
	45100	35	12	•	•	
	45100	40	00	•	•	
	45100	40	12	•	•	
	45100	50	00	•	•	
	45100	50	12	•	•	
	45100	60	00	•	•	
	45100	60	12	•	•	
	45110	40	00	•	•	
	45110	40	12	•	•	
	45110	50	00	•	•	
	45110	50	12	•	•	
	45110	60	00	•	•	
	45110	60	12	•	•	
	45112	60	12	•	•	



Technical features:

- Steel faceplate and strike.
- Zinc plated steel case
- Flat reversible nickel plated latch.
- Three DOUBLE throw nickel plated steel bolts.

Operation:

- From outside or inside: the latch is operated by key or handle; the deadbolts are operated by key only.

Supplied as standard:

- Striker
- Fixing screws for lock and striker
- Cylinder fixing screw.

Available finishes:

- Laquered satin brass plated.

Hand:

0 = Non-handed

Type	Description	Throws	Code	Backset	Finish	Price including Cylinder	Price without Cylinder
	<p>Latch and multiple bolts</p> <ul style="list-style-type: none"> • Strike 06278-11 • Cylinder 0E300-10 						
	Brass plated	2	52521	60	00	•	•
	Nickel plated	2	52521	60	12	•	•

SECURITY LOCKS WITH DOUBLE BITTED KEY – 4 THROW DEADBOLT



Technical features:

- Nickel Plated satin steel faceplate and striker.
- Zinc plated steel case.
- Reversible nickel plated latch.
- Nickel plated steel deadbolt.

Operation:

- From outside or inside: the latch is operated by key or handle; the deadbolt is operated by key only.

Supplied as standard:

- Striker
- Fixing screws for lock and striker
- 2 escutcheons: inside item 06143, outside item 06082
- 3 Keys

Hand:

0 = Non-handed

Type	Description	Key Item	Throws	Code	Backset	Finish	Price
	<p>Deadbolt only</p> <ul style="list-style-type: none"> • Strike 06213 	<p>00100.00.1</p>	4	57010	50		•
	<p>Deadbolt only</p> <ul style="list-style-type: none"> • Strike 06213 • Drill resistant plates 	<p>00101.00.1</p>	4	57014	50		•
	<p>Latch and deadbolt</p> <ul style="list-style-type: none"> • Strike 06271 	<p>00100.00.1</p>	4	57250	60		•

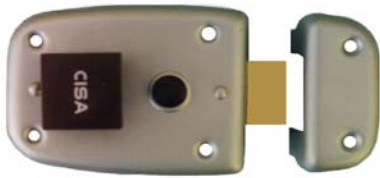

Technical features:

- Steel case and striker painted GREY (finish 97).
- Brass latch and deadbolt.
- PVC Knobs.
- Three DOUBLE throw nickel plated steel bolts.

Supplied as standard:

- Striker
- Fixing screws for lock and striker
- Instruction sheet.

Hand:

0 = Non-handed

Available finishes:

- Painted GREY (finish 97) only.

Type	Description	Cylinder	Code	Backset	Finish	Price
	<p>Night Latch.</p> <ul style="list-style-type: none"> • Cylinder 0G500 • Grey colour only (finish 97) • Inside knob • Dead locking latch with hold-open device. 		54315	60	97	•
	<p>Deadbolt only</p> <ul style="list-style-type: none"> • Cylinder 0G500 • Grey colour only (finish 97) • Inside knob 		54340	60	97	•

SECURITY RIM LOCKS WITH MULTIPLE DEADBOLTS - DOUBLE BITTED KEY

Type	Description	Key	Code	Backset	HAND	Price
	<p>Four throw deadbolt and latch</p> <ul style="list-style-type: none"> • Six levers • Anti drill protection • Five locking points • Includes extension bolts – 06426-01-0 • Subsidiary driving mechanism 57190. • Includes escutcheons • Blank key ref 00125 		57175 57175	60 60	1 2	• •



Principal Features:

- Rim Lock with latch and dead-bolt.
- Brass latch and deadbolt.
- Suitable for Knobs with 8mm spindle.
- Locks have 12 differs.
- Supplied with 2 keys



Packed in Clear Blister Pack with instructions

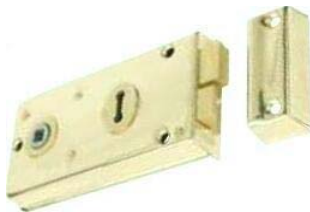

Brass Plated

P2136

BP

•



Matt Black

P2136

BM

•

BRASS VICTORIAN DOMED KNOBS WITH ESCUTCHEONS.



51mm Brass Knobs for Rim Locks

P472

51

2

•

Packed in Clear Blister Pack with instructions

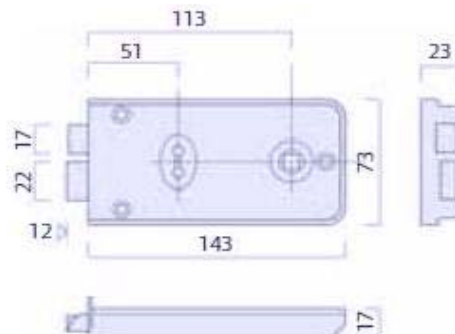



Technical features:

- Laquered polished brass removable faceplate and striker.
- Zinc plated steel case.
- Reversible nickel plated silent action deadlocking latch.
- Nickel plated cut resistant deadbolt, with 25mm protrusion.
- Anti corrosion galvanised internal components.

Available finishes:

- On Request: Satin Stainless steel faceplate and strike (finish 20).

Supplied as standard:

- Striker and fixing screws
- Without cylinder.
- Instruction sheet



Standards:

- Locks with stainless steel faceplate and strike (finish 20) are certified fire-resistant by the American Underwriters Laboratory (UL Listed R14945(N).

Hand:

0 = Non-handed

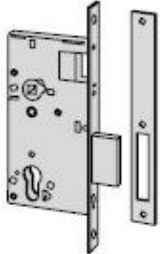
Type	Description	Code	Backset	Finish	Price
	<ul style="list-style-type: none"> • Silent action deadlocking latch bolt only • Supplied with strike 06158-20, without cylinder. • Suitable for use with panic devices 59711 and 59607 <p>For Panic Function external doors.</p> <ul style="list-style-type: none"> • Operation: - The latch bolt is operated by handles or cylinderfrom both sides. - The outside handle must be fixed. <p>Classroom door lock with panic function.</p> <ul style="list-style-type: none"> • Operation: - The latch bolt is operated by handlefrom both sides. - The outside handle can be activated andde-activated by cylinder. • Uses split spindle 07206 	<p>52755</p> <p>52755</p>	<p>60</p> <p>60</p>	<p>00</p> <p>20</p>	<p>•</p> <p>•</p>
	<ul style="list-style-type: none"> • Silent action deadlocking latch and 25mm deadbolt. • Supplied with strike 06106-20, without cylinder. • Suitable for use with panic devices 59711 and 59607 <p>Entrance doors- Not Panic Function</p> <ul style="list-style-type: none"> • Operation: - The latch bolt is operated by handle or cylinderfrom either side. - The deadbolt is operated by cylinder from either side. <p>Panic Function doors with Automatic deadbolt.</p> <ul style="list-style-type: none"> • Operation: - Deadbolt automatically locks when door is closed. - The latch bolt is operated by handle or cylinderfrom either side. - The handle withdraws the latch and deadboltsimultaneously. - The outside handle must be fixed. <p>Hotel Lock with panic function</p> <ul style="list-style-type: none"> • Operation: - The latch bolt is operated by handle or cylinderfrom either side. - The handle withdraws the latch and deadboltsimultaneously. - The outside handle must be fixed. • Optional: Cylinder 08453 and Indicator of occupancy. <p>Classroom door lock with panic function.</p> <ul style="list-style-type: none"> • Operation: - The latch bolt is operated by handle from either side. - The deadbolt is operated by cylinder from either side. - The inside handle withdraws the latch and deadboltsimultaneously. With reversible panic function. • Uses split spindle 07206 	<p>52710</p>	<p>60</p>	<p>20</p>	<p>•</p>
	<ul style="list-style-type: none"> • Silent action deadlocking latch and 25mm deadbolt. • Supplied with strike 06106-20, without cylinder. • Suitable for use with panic devices 59711 and 59607 <p>Entrance doors- Not Panic Function</p> <ul style="list-style-type: none"> • Operation: - The latch bolt is operated by handle or cylinderfrom either side. - The deadbolt is operated by cylinder from either side. <p>Panic Function doors with Automatic deadbolt.</p> <ul style="list-style-type: none"> • Operation: - Deadbolt automatically locks when door is closed. - The latch bolt is operated by handle or cylinderfrom either side. - The handle withdraws the latch and deadboltsimultaneously. - The outside handle must be fixed. <p>Hotel Lock with panic function</p> <ul style="list-style-type: none"> • Operation: - The latch bolt is operated by handle or cylinderfrom either side. - The handle withdraws the latch and deadboltsimultaneously. - The outside handle must be fixed. • Optional: Cylinder 08453 and Indicator of occupancy. <p>Classroom door lock with panic function.</p> <ul style="list-style-type: none"> • Operation: - The latch bolt is operated by handle from either side. - The deadbolt is operated by cylinder from either side. - The inside handle withdraws the latch and deadboltsimultaneously. With reversible panic function. • Uses split spindle 07206 	<p>52840</p>	<p>60</p>	<p>20</p>	<p>•</p>
<ul style="list-style-type: none"> • Silent action deadlocking latch and 25mm deadbolt. • Supplied with strike 06106-20, without cylinder. • Suitable for use with panic devices 59711 and 59607 <p>Entrance doors- Not Panic Function</p> <ul style="list-style-type: none"> • Operation: - The latch bolt is operated by handle or cylinderfrom either side. - The deadbolt is operated by cylinder from either side. <p>Panic Function doors with Automatic deadbolt.</p> <ul style="list-style-type: none"> • Operation: - Deadbolt automatically locks when door is closed. - The latch bolt is operated by handle or cylinderfrom either side. - The handle withdraws the latch and deadboltsimultaneously. - The outside handle must be fixed. <p>Hotel Lock with panic function</p> <ul style="list-style-type: none"> • Operation: - The latch bolt is operated by handle or cylinderfrom either side. - The handle withdraws the latch and deadboltsimultaneously. - The outside handle must be fixed. • Optional: Cylinder 08453 and Indicator of occupancy. <p>Classroom door lock with panic function.</p> <ul style="list-style-type: none"> • Operation: - The latch bolt is operated by handle from either side. - The deadbolt is operated by cylinder from either side. - The inside handle withdraws the latch and deadboltsimultaneously. With reversible panic function. • Uses split spindle 07206 	<p>52842</p>	<p>60</p>	<p></p>	<p>•</p>	
<ul style="list-style-type: none"> • Silent action deadlocking latch and 25mm deadbolt. • Supplied with strike 06106-20, without cylinder. • Suitable for use with panic devices 59711 and 59607 <p>Entrance doors- Not Panic Function</p> <ul style="list-style-type: none"> • Operation: - The latch bolt is operated by handle or cylinderfrom either side. - The deadbolt is operated by cylinder from either side. <p>Panic Function doors with Automatic deadbolt.</p> <ul style="list-style-type: none"> • Operation: - Deadbolt automatically locks when door is closed. - The latch bolt is operated by handle or cylinderfrom either side. - The handle withdraws the latch and deadboltsimultaneously. - The outside handle must be fixed. <p>Hotel Lock with panic function</p> <ul style="list-style-type: none"> • Operation: - The latch bolt is operated by handle or cylinderfrom either side. - The handle withdraws the latch and deadboltsimultaneously. - The outside handle must be fixed. • Optional: Cylinder 08453 and Indicator of occupancy. <p>Classroom door lock with panic function.</p> <ul style="list-style-type: none"> • Operation: - The latch bolt is operated by handle from either side. - The deadbolt is operated by cylinder from either side. - The inside handle withdraws the latch and deadboltsimultaneously. With reversible panic function. • Uses split spindle 07206 	<p>52844</p>	<p>60</p>	<p></p>	<p>•</p>	

Type	Description	Code	Backset	Finish	Price
	<ul style="list-style-type: none"> • Supplied with strike 06159-20, without cylinder. • Suitable for use with panic devices 59711 and 59607 • Deadbolt only with panic function • Operation: <ul style="list-style-type: none"> - The deadbolt is operated by handle or cylinder - ...from either side. - The outside handle must be fixed. 	52871	60		•
	<p>Optional</p> <ul style="list-style-type: none"> • Rebate Kit for 52755, 52840 etc • Indicator of occupancy for 52840 • Split follower for 52760, 52844 	528RB 06146 07206	00 00 01	00 00 01	• • •

ADJUSTABLE ROLLER LATCH

Type	Description	Code		Finish	Price
	SEE PAGE 00.12				

