

badmagazin

Edition 4

Duravit Showrooms: Hornberg and Meißen (Germany), Paris (France), New York (USA), Kairo (Egypt), Bizerte (Tunisia) und Shanghai (China). More information? www.duravit.com/showrooms

badmagazin

P. 70
BATHROOM RANGE HAPPY D.2
Reinterpreting an archetype

P. 122
FURNITURE PROGRAMME X-LARGE
Extra storage space,
extra light, extra flexible

P. 158
SENSOWASH®
SHOWER TOILET
FOR THAT
FRESHLY-WASHED
FEELING



CREATING YOUR
DREAM BATHROOM
Outstanding design ranging from the entry-level to the luxury bathroom

Best-Nr. 001274/22.12.13.14.1 - Printed in Germany - We reserve the right to make technical improvements and enhance the appearance of the products shown.

Edition 4

www.duravit.com

What do you need to be able to design an attractive, practical and sustainable bathroom? How about technological innovation, outstanding design expertise and the very highest product quality - the very things that make every Duravit product unique.

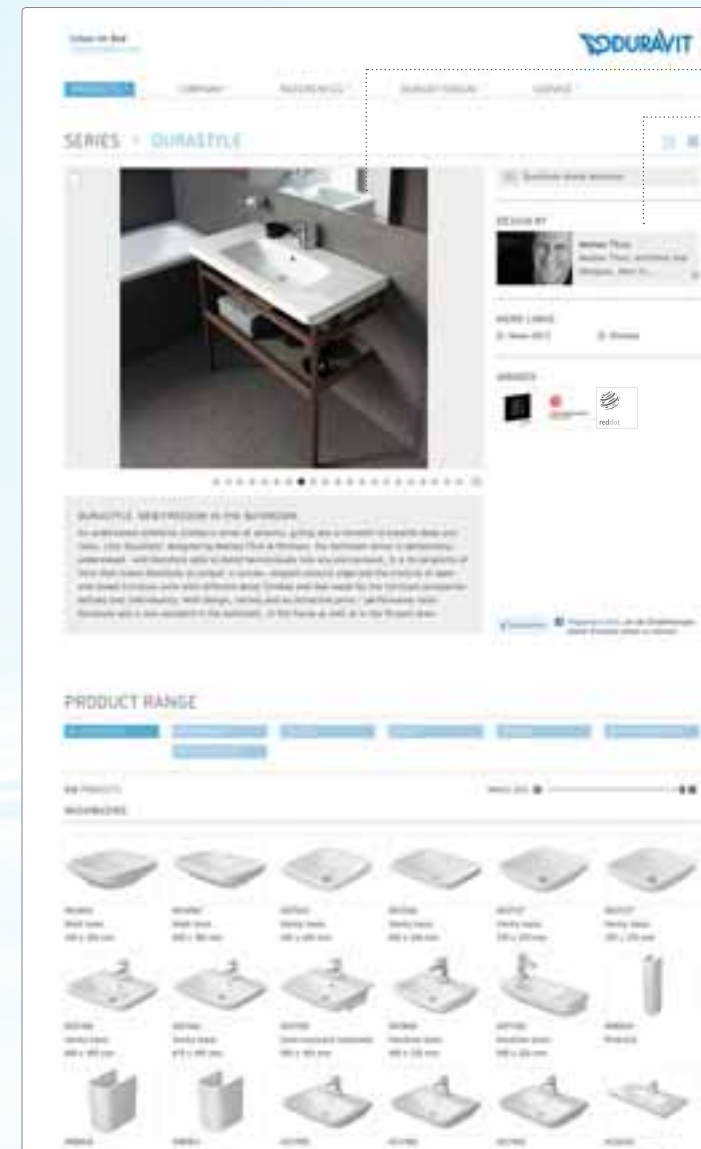

- Description of series and products
- Designers and design awards
- Overview of forms and sizes

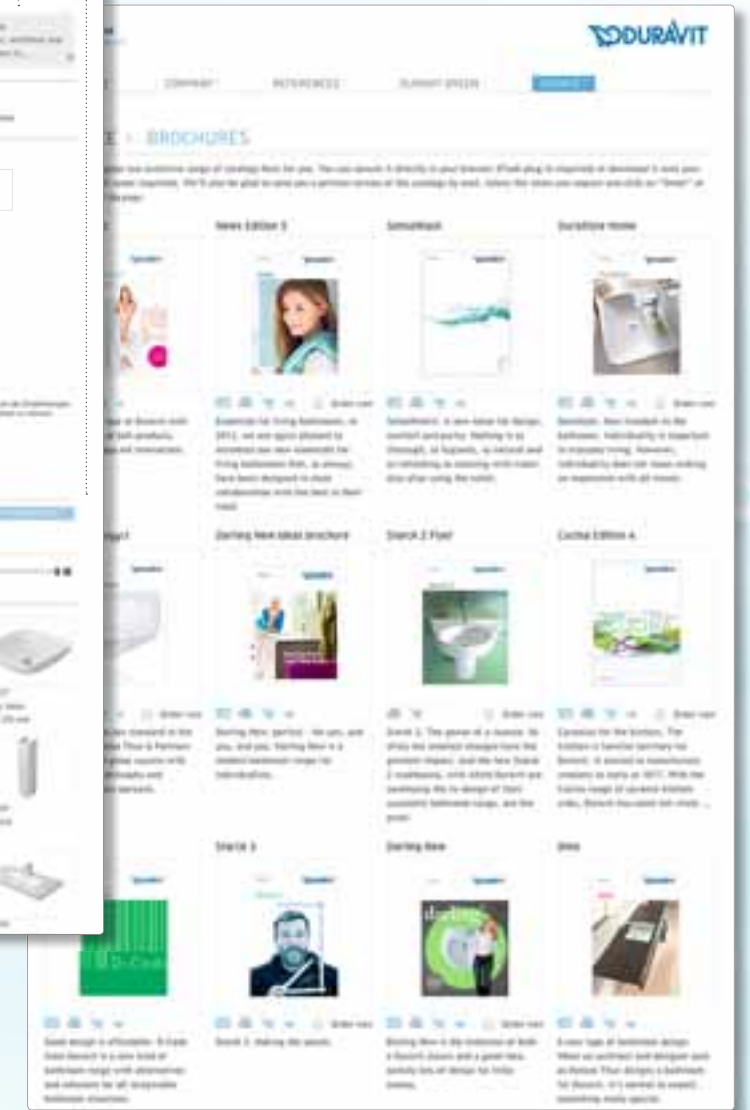

MORE INFORMATION?

www.duravit.com

If you have any questions, need help with planning or simply want to find out more about Duravit, please contact your local specialist dealer. You will find a list of dealers who stock Duravit products on our website.

Download brochures from www.duravit.com/brochures



DURAVIT brings the
bathroom to life!

Now, wouldn't you

LIKE A NEW

Duravit bathroom?



CREATING YOUR DREAM BATHROOM

The bathroom is increasingly becoming a furnished living area that also serves as a private spa with multifunctional products for maximum comfort. We have put together some key information that will help you on your way to your new bathroom.

PAGE 6

Features	240
Furniture finishes	246
Duravit brand	250

BATHROOM FURNITURE

CABINETS, VANITY UNITS, MOBILE STORAGE UNITS, LIGHTING PERFECTLY ADJUSTED FOR THE DURAVIT SERIES

2nd floor	44
Darling New	16
Delos	28
DuraStyle	104
Esplanade	144
Fogo	52
Happy D.2	70
Ketho	132
PuraVida	36
Starck	80
X-Large	122

SANITARY CERAMICS

EVERYTHING FOR THE WASHING AREA & CO: WASHBASINS, HANDRINSE BASINS, TOILETS AND BIDETS

2nd floor	44
Architec	112
Bacino	120
Bagnella	119
Caro	152
Darling New	16
DuraStyle	104
Esplanade	144
Foster	150
Happy D.2	70
PuraVida	36
Scola	118
SensoWash®	158
1930 Series	140
Starck 1	80
Starck 2	90
Starck 3	98
Vero	60



PAGE 16



PAGE 158



SENSOWASH®

A pioneering innovation in the world of shower-toilet seats.



PAGE 122

NEW



PAGE 28

WELLNESS

POOLS, SAUNAS, LIGHTING SYSTEMS: ALL THAT MAKES LIVING BATHROOMS EVEN MORE COMFORTABLE

Blue Moon Pools	212
Inipi Sauna	230
Inipi B Sauna	236
Nahho	198
OpenSpace	222
St.Trop	226
Sundeck Pools	206
Pool systems	216

Colored light, sound and whirl technology 192



PAGE 230



PAGE 180

BATHTUBS + SHOWER TRAYS

FOR ALL ROOM LAYOUTS: BATHTUBS FOR CORNER, BACK-TO-WALL, BUILT-IN AND FREESTANDING

Freestanding bathtubs	174
Back-to-wall bathtubs	178
Built-in bathtubs	184
Corner bathtubs	186
2x3	188
2nd floor	178, 186
Blue Moon	208
Darling New	182, 183, 188
Daro	186
DuraStyle	179, 185
Esplanade	178, 184, 188
Happy D.2	176, 183, 186
Paiova Monolith	180
Paiova	189
PuraVida	178, 183, 186
Starck	177, 178, 183, 185, 187
Sundeck	202
Vero	180, 183
Tub covers	190
Shower trays	218



PAGE 176

NEW

SPECIALS

164 SETTING THE TONE
BATHROOM RANGES AND DECO IDEAS IN WHITE, NATURAL, ANTHRACITE AND BLACK

170 CUCINA
CERAMIC KITCHEN SINKS. THE WORK OF HIGH-PROFILE DESIGNERS.





IN 5 Your DREAM BATHROOM STEPS

The bathroom is becoming increasingly important as a living area and somewhere to relax; a bathroom that is based on individual needs. Your personal dream bathroom meets complex requirements and encompasses every imaginable area of the bathroom to form one unique design.

We have put together the key points you should take into account in your planning. With a specialist at your side, you won't be in for any unpleasant surprises when realising your dream Duravit bathroom. You will be supported right from the initial consultation through project realization and given expert guidance on how best to proceed.

WHAT DOES THE FUTURE HOLD?

What changes can you expect in the foreseeable future? Does the new bathroom have to be suitable for children, or should the age of its users not play a role in its design?

BATHROOM PLANNING

Modern, computer-aided 3D bathroom planning, a collage of materials or sample tile layouts, wood finishes and wall coverings: together, these elements give you an accurate picture of how your finished bathroom will look.

1 WHAT DOES YOUR DREAM BATHROOM LOOK LIKE?

Which practical areas and how much comfort do you want in your new bathroom? How will the different members of your family use the bathroom on an everyday basis?

2 WHAT'S RIGHT FOR YOUR BATHROOM IN TERMS OF SIZE AND STYLE?

The Duravit range has something for every ambience and furnishing style and for any amount of available space. On the following pages of our Badmagazin, you will find the products that best meet your own personal taste. Or, we invite you to visit one of our showrooms.

3 SO NOW ALL YOU HAVE TO DO IS ENJOY!

Once the bathroom has been tidied and organized, you can lie back, relax and enjoy your new ultimate wellness space.

Comfort FOR ALL STAGES IN LIFE

BATHROOM PRODUCTS FROM DURAVIT OFFER ADDED VALUE

According to a recent study by the VDS (German Sanitation Industry), 88% of the population would like age-appropriate bathroom furnishings.

In regards to the long lifetime of a bathroom, many people, including those in their younger years, are concerned with how the bathroom can adapt to future stages of their lives and meet a growing need for comfort, practicality and safety. In this context, comfort is not an age-related issue – it enhances the quality of life for people of all ages.



SMART BATHROOM IDEAS FOR ADDED SAFETY

How safe you feel in your own home contributes significantly to your feeling of well-being. Night-light programs, like those used in the mirror cabinets in the PuraVida and Multibox series, as well as in the 2nd floor mirror (2) and the SensoWash® shower-toilet seat (1), provide sufficient orientation and safety in the dark. With a light brighter than 200 lux, the body enters waking mode. For this reason, it is better to use a special LED night light that enables users to safely find their way around when it's dark without interrupting the body's repose.

Duravit counters the danger of slipping on wet surfaces with targeted measures, such as steps for baths that enhance safety and facilitate entry and exit. (3)

All Duravit shower trays are also available with an anti-slip coating. Thanks to this transparent but effective coating, feet gain a more secure hold in the shower. (4)

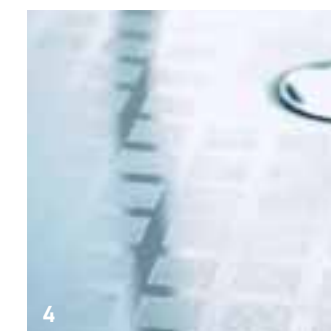

TAKE A SEAT!

The X-Large mobile storage unit not only serves as a practical storage space but also as an upholstered seat.

PRODUCTS THAT MAKE EVERYDAY LIFE EASIER

How do you switch the light on and off with soapy hands, or operate the dimmer switch? Not a problem thanks to the Duravit touchless control mirrors and mirror cabinets. Shown here: X-Large (5).

It takes just a tap of the fingertip to open the drawers and pull-out elements of the Delos and Starck furniture programs. The X-Large mobile storage units are also practical aids in everyday life and, as flexible upholstered seats, provide practical storage space (right). The DuraStyle bench with cushion provides an opportunity to rest and relax (6). Large, integrated drawers can be used to store towels and bathroom accessories.



PROVIDING GREATER FREEDOM OF MOVEMENT

Shower trays that fit flush with the floor offer maximum comfort and are even wheelchair-accessible. In conjunction with the OpenSpace shower partition (1) that can be folded back against the wall, they offer even greater comfort.

The new Starck Slimline shower trays measuring up to 180 x 90 cm offer ample space in which to unwind in the shower.



Console basins provide sufficient legroom for comfortable use of the washing area, even when seated. Particularly flat washbasin models, such as the Vero washbasin, which measures only 165 mm in height, are wheelchair-friendly and also meet discerning design requirements.

and also meet discerning design requirements.



EASY ENTRY.

In the Starck Slimline shower tray, the rim height has been reduced to 20 mm, available in sizes from 80 x 80 cm to 180 x 90 cm.

2

The Starck 3 wall-mounted toilet offers a five-centimetre higher seated position that makes it easier for the user to stand up after using the toilet. It uses existing connections, making it ideal for renovation projects. For tall people and all those looking to make life easier as they grow older, the higher wall-mounted toilet offers a better sitting position +50. Starck 3 also features a barrier-free wall-mounted WC. When a urinal is installed, it's not even necessary to sit down and stand up.

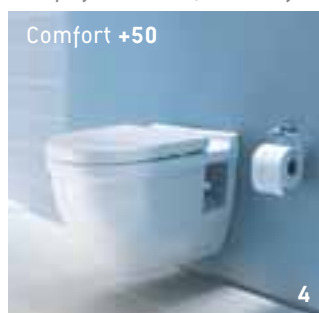

INNOVATIVE SOLUTIONS FOR GREATER COMFORT

Well-designed drawers help to keep things tidy. Glass dividers and practical compartments help users keep track of what's inside. In the Delos bathroom program, a new, intelligent, interior organization system in either walnut or maple ensures a particularly tidy and high-quality interior solution (below).



Mirrors in various widths adapt to the respective washing area and illuminate it to perfection. Mirror cabinets also offer practical features: the additional storage space at eye level, the integrated light and the mirrors on the inside of the doors are just some of the advantages. Integrated sockets and touch LED switches are also standard functions of Duravit products in all price categories. (5)

HYGIENE

WonderGliss. The WonderGliss coating that is baked into the ceramic doesn't give grime a chance: dirt and limescale cannot secure a hold on the smooth surface, so residue runs off more easily with the water. Sanitary ceramics featuring WonderGliss stay smooth and clean for longer and are thus extremely easy to clean. All it takes is a soft cloth and mild cleaning agent.



SENSOWASH®

AT THE PUSH OF A BUTTON

The SensoWash® shower-toilet solutions offer cleanliness and freshness at the push of a button. Large, clear symbols on the remote control are also suitable for the elderly with restricted movement.



SENSOWASH®

SensoWash® shower-toilet seat. For that freshly-washed feeling. Nothing is as thorough, as hygienic, as natural and as refreshing as cleaning with water. After using the toilet too: this is why Duravit developed SensoWash® – a pioneering innovation in the world of shower-toilet-seats that redefines comfort, quality of life and modern toilet hygiene, from gentle

cleaning to pleasant drying, all operated by a remote control. SensoWash® is available in three comfort classes and compatible with toilets from the Starck 2, Starck 3, Darling New, DuraStyle, Happy D.2 and D-Code series. Would you like to find out more?

www.sensowash.com

SPECIAL TREATS TAILORED TO YOUR BATHING NEEDS

Generous dimensions and ergonomically shaped bathtubs that are kind on the back are features common to all Duravit baths. Padded neckrests are accessories that provide for improved comfort in a reclining position.

The Darling New bath features an extra-wide rim with adequate space for sitting. Products that fulfil several functions simultaneously meet the complex requirements of modern bathroom users. For example, the Sundeck bath can be transformed into an upholstered lounger, while in a semi-unfolded state, it serves as a seat for an invigorating foot bath (7). The universal covers can also be fitted to the other models to turn them into practical surfaces for sitting and lying on. (8)

The particularly flat baths in the DuraStyle and Nahho programs make it easier to get in and out, which means they are also ideal as bath and shower combinations.





FEELS GOOD AND DOES YOU GOOD

A full-fledged shower for daily use that doubles as a powerful steam bath offering temperatures from 42 to 50 degrees Celsius at 100 % humidity: the St. Trop steam shower with stool is a compact treat for the respiratory passages and skin that is truly relaxing. (1)

As a sauna for the living area, Inipi and Inipi B offer a retreat from everyday life, with space for one or two in a sitting or lying position. The positive effect on health is proven: using a sauna regularly strengthens the immune system, purifies the body, increases resistance to stress, keeps the heart and circulation healthy and prevents aches and pains (below).

The bubbling water in bathtubs or pools with a whirl function stimulates the tissue under the skin and massages specific areas of the back.

The Nahho flotation tub is equipped with a special whirl system, the Durapearl Jets (2, 3). These base jets provide a bubbling mixture of water and air for total relaxation.

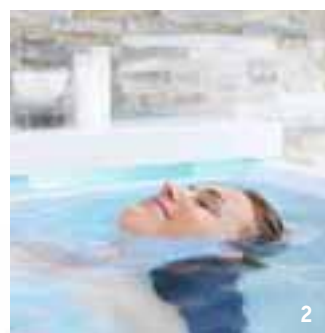

HEALTHY SWEATING

Inipi – the sauna for the bathroom and living area. The Inipi sauna has an ingenious layout and offers lots of transparency so it harmonizes beautifully with its surroundings.

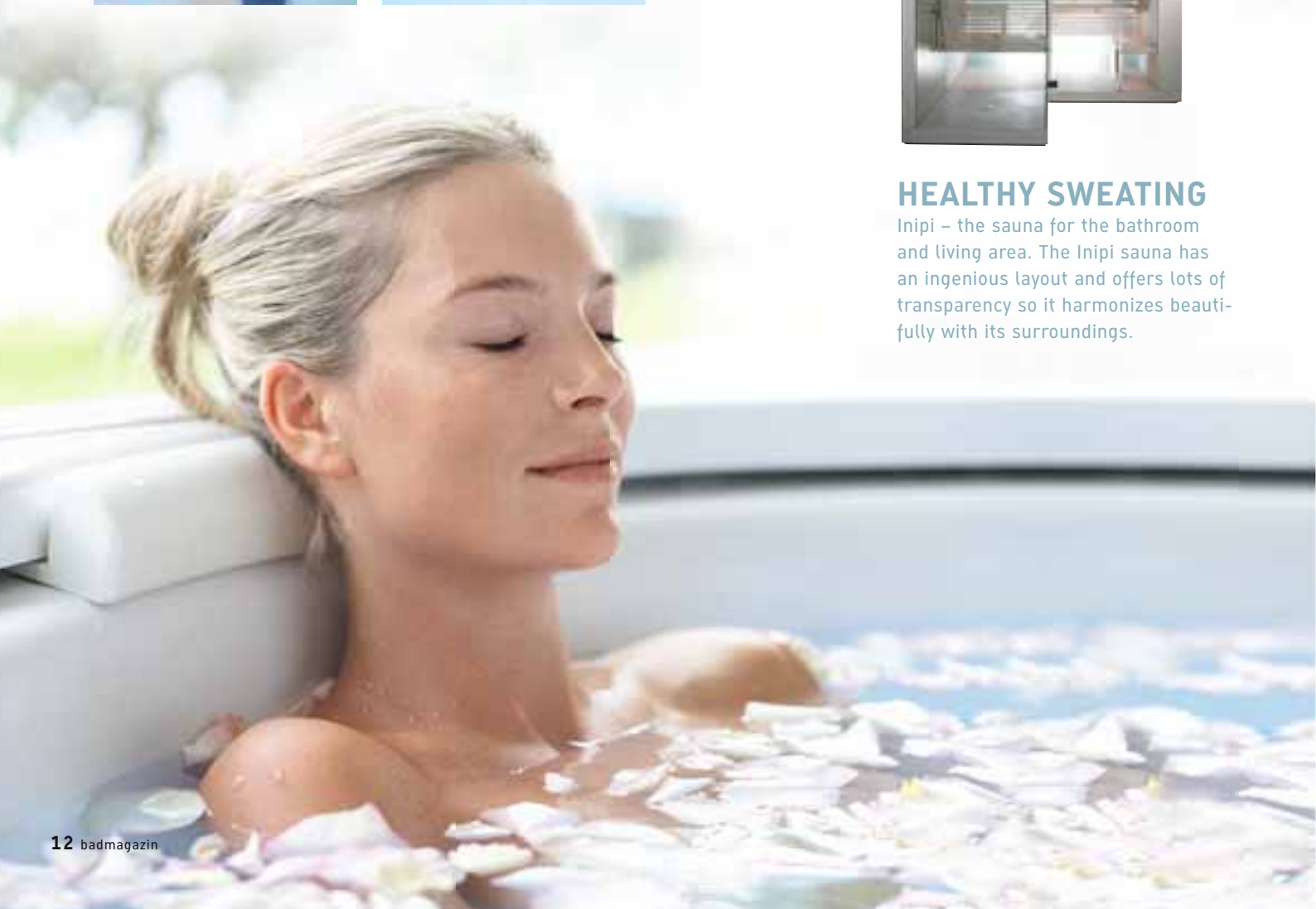

SUSTAINABLE DESIGN WITH NO EXPIRATION DATE

A Duravit bathroom is always a great investment in the future: the high product quality, the many years of experience and the collaboration with high-profile international designers not only ensure lasting beauty but also timelessly modern forms without an expiration date. Duravit keeps a close eye on user requirements and capabilities and offers products that are suitable for use throughout the different stages in life.



1



BIG LITTLE BATHROOMS

What comes to mind when you hear the term „guest bathroom“? Cramped, functional, austere? At Duravit, we aim to correct these misconceptions by offering an array of flexible products for compact room layouts and innovative solutions for guest bathrooms and powder rooms, which come complete with properties such as: spacious, inviting, creative, cozy... and simply beautiful. See for yourself!

The washing area is at the epicenter of the bathroom, and Duravit offers an extensive repertoire – everything from hand-rinse and built-in washbasins with vanity units to countertop basins and matching consoles in various dimensions and styles – to address the design of the washing area. The Starck 1 range (1-3) offers great ideas for exclusive guest bathrooms. The barrelshaped washbasin and furniture unit is already a classic.

The Starck 2 series is not only extremely attractive but also extremely practical. For example, it includes a compact hand-rinse basin that is 50 cm wide and nevertheless has a generous surround. The SensoWash® Starck shower-toilet seat is the perfect complement to the Starck 2 wall-mounted toilet.



2

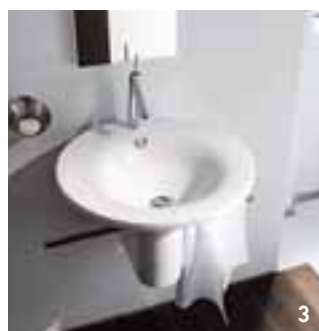

3



5

OpenSpace. The shower enclosure that enlarges the bathroom. After showering, the doors can simply be „folded“ back against the wall. This avoids a rail protruding into the room and allows for the bathroom to appear much larger, particularly with the mirrored glass option. (5)



4



6



The Starck 3 range also masters limited space with consummate ease by offering an attractive and petite hand-rinse basin and a compact wall-mounted toilets and bidet.

Duravit also offers both functional and attractive solutions wherever space is at a premium with versatile ceramic options and bathroom furniture that offers lots of storage space.

paint finishes, each bathroom can be customized to meet the user's individual taste. An entire range of matching mirrors and mirror cabinets, either with or without lighting, add the finishing touch to the perfect mini bathroom furnishings.



Shorter projection, morespace. Wherever space is particularly tight, toilets with a shorter projection are great problem-solvers. At Duravit, these are known as compact designs (6). A urinal is both a practical and hygienic addition to a bathroom, and, if installed in more private areas, is even available with a cover. The Starck model, for example, is simple, attractive and incredibly practical (on the left).

Narrow dimensions, masses of storage space. Duravit offers bathroom furniture with economical outer dimensions and a spacious interior in a wide variety of different sizes, variants and forms.

The guest bathroom and powder room achieve maximum comfort thanks to furniture elements such as shelves, storage surfaces and cabinets available in a wide variety of dimensions and designs to enable maximum flexibility. For smaller room layouts in particular, Duravit's creative bathroom furniture ideas are often the only way to create storage space or useful surfaces. Thanks to the large selection of different real wood veneers, décors and





DARLING NEW 
Perfect – for you,
and you, and you.
Darling New is a
modern bathroom
range for
individualists.



Design by sieger design

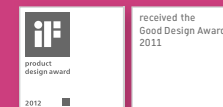

The harmonious form, filigree edges and a practical design language combine to produce a timelessly chic bathroom with limitless possibilities. With its large selection of attractive wood décors and plain surfaces, individual washbasin solutions and friendly prices, Darling New is the perfect answer for all bathrooms. You can configure your own personal arrangement at www.mynewdarling.com





Endearingly individual. As people today want to be able to make their own decisions, Darling New offers four different washing area variants, all of which are equally attractive. The 'pure' solution – washbasin plus pedestal or semi-pedestal – showcases the basin's harmonious circle-within-a-circle to optimum effect. As does the delicate edge that features throughout the range.



The delicate edge is the visual leitmotif of the range and is to be found on both the washbasin and the toilet (1). The Darling New toilet with matching SensoWash® Starck C shower toilet seat communicates a new feeling for design, comfort and purity. The connections for water and electricity are elegantly concealed (2). The Darling New bathtubs offer attractive and effective wellness: here as back-to-wall with acrylic panel (3).



Darling New. Straight to the heart.





STYLISH
The contrast between the white ceramics and the dark tones of the wood décor fronts and bodies is especially stylish.



The Darling New bathtubs offer attractive and effective wellness: As an option, a soft, white, atmospheric LED light shimmers below the rim. Also available with attractive bath panelling, here in Pine Terra. The wide bath rim serves as a comfortable seat and the optional neckrest promises additional relaxation (1). The furniture washbasin offers impressively generous shelf areas and a delicate design, even in the smallest size (2). The tall cabinet (3) and semi-high cabinet offer lots of practical storage space, whilst the tall cabinet with shelves is resplendent with its integrated mirror.

GOOD REASONS FOR DARLING NEW

- + Fresh bathroom design by sieger design: new forms, colors and finishes
- + Unique design of the washbasins, toilets and bidets with delicate edges
- + Solutions for small and large bathrooms
- + Extensive furniture program



Fresh cell therapy in the bathroom. Grey-in-grey is passé. New Darling injects a spring-like feeling into the bathroom all year round. The modern forms of the ceramics, tubs and furniture give fresh wind, and the attractive furniture surfaces add the finishing stylish touch.

► SensoWash® from p. 158 ► Bathtubs and shower trays from p. 172 ► Overview of furniture finishes from p. 246



DELOS.

Comfort and elegance. The Delos range of bathroom furniture sets new standards in terms of both minimalist and comfortable bathroom design.

Design by E00S

There are no handles to interrupt the clear aesthetics: the cabinets have slightly overlapping doors and the drawers are opened by tip-on technology. The console has an almost invisible support system which give it a light floating effect. Delos lights and mirrors feature the same reduced design: the mirror and console rear wall form a flat surface that is crowned by a canopy of light. The mirror and mirror cabinet feature mirrors on all sides.



1



2



3



SOUNDSYSTEM

The mirror cabinets of the series Delos are optionally available with an integrated sound system: music can be streamed via all Bluetooth-compatible devices.



4



5

(1) Delos drawers can be opened and closed with gentle pressure. The drawers are optionally available with an interior organization system in walnut or maple. (2) Towel holders can be attached to any side of the console. On the one hand, they add volume to the outer edge of the contour and, on the other hand, they act as an expressive, sculptural finish at an optimum, ergonomic height. (3) The special light canopy with indirect, non-glare LED-light ensures good lighting and creates a pleasant atmosphere. (4, 5) There are no handles to interrupt the clear aesthetics: the cabinets have slightly overlapping doors and the drawers are opened by tip-on technology.





Vero, Starck and Paiova offer baths with Brushed Walnut panelling – the perfect complement to bathroom furniture from the Delos series.



(1) The drawers are optionally available with an interior organization system in walnut or maple. The Darling New, D-Code and Vero ceramic ranges are the perfect complement, as are console basins from many other Duravit ranges. (2, 3) All cabinets, shown here in the surface brushed walnut, are diamond black on the inside. (4, 5) The console has an almost invisible support system which give it a light floating effect.



For more information about how to fit washbasins flush into furniture (bonded method), see page 242

GOOD REASONS FOR DELOS

- + Innovative minimalist design by E00S
- + Handleless doors and drawers
- + Real-wood surfaces with a textured finish
- + The consoles appear to float as if they have no visible supports
- + Perfect illumination of the mirrors thanks to innovative LED technology



Attractive details for living bathrooms: matching accessories of the series Karree



Delos for the main bathroom, guest bathroom or powder room. The special light canopy with indirect, non-glare LED-light ensures good lightning and creates a pleasant atmosphere. The real-wood, brushed oak surface with a grain finish gives the range an authentic feel. The robust glass shelves are available with invisible aluminium supports, which are anodized to match the interior color. The sensor light switch sits discreetly on the mirrors edge (1).

► Bathtubs and shower trays from p. 172 ► Overview of furniture finishes from p. 246



PURAVIDA.

With its rounded corners and characteristic curve, the PuraVida complete range creates a new lightness in the bathroom.

Design by Phoenix Design



The more complex and advanced our world becomes, the more we desire an escape to a new more "emotional" way of seeing things. The brainchild of Phoenix Design, the design of this extraordinary complete range makes minimalism approachable by giving it a new feminine touch. All lines are gently softened giving the range a poetic lightness. PuraVida's graceful appearance, inviting surfaces and subtle luxury make the collection ideal for people who are not interested in prestige but in contemporary forms, enjoyment and joie de vivre.



The free-standing PuraVida bathtubs features simple, uninterrupted lines. The collection of PuraVida baths comprises one free-standing, one console and three built-in versions.



The recessed grip on the PuraVida tall cabinet opens both the upper and the lower element. Inside, the furniture sports many attractive and practical details, such as the rails on the inside of the doors. The cabinets themselves are available with glass shelves; a narrow drawer is also integrated into the centre shelf.



(Above) The PuraVida+ washbasin and console basin with double depth.



A special feature of the PuraVida range is the high-gloss furniture finish – dignified but not flashy. The possible color combinations are white/white, white/aluminium, white/red, white/black and white/ebony. White/red and white/black are available in two different tones and combinations. In addition to the consoles shown, the entire furniture range from the vanity unit to the mobile storage unit is available in all variants. The consoles are variable with a width of up to 2000 mm; all variants can be combined with one or two washbasins. The matching mirrors and mirror cabinets are available in various widths.



GOOD REASONS FOR PURAVIDA

- + Luxurious and modern
- + Soft, yet distinctive design by Phoenix Design
- + Unique furniture design



The rounded corners and unmistakable PuraVida lines also feature in the toilet area. The toilet and bidet are available both in the 36 x 54 cm wall-mounted version (left) and in the 36 x 63 cm floor-standing version with visible cistern (above). Once again, the parts appear to float and communicate the typical PuraVida lightness. All toilet seats feature the silent SoftClose lowering mechanism.

► WonderGliss p. 241 ► Bathtubs and shower trays p. 172



2ND FLOOR.

With flat forms and warm wood finishes, the entire 2nd floor range ensures an elegantly furnished bathroom.

Design by sieger design



We no longer consider the bathroom a separate, isolated room, but instead an open, cozy seamless space. With 2nd floor, sieger design and Duravit pay tribute to this idea. A combined high-quality design collection and comfortable furniture range, 2nd floor uses simple means to design an elegant, inviting room. Its many warm wood elements provide an engaging contrast to the white of the ceramic and sanitary acrylic. Thanks to a variety of available dimensions and options, it is possible to create an attractive washing area in every architectural situation, including smaller rooms, such as guest bathrooms and powder rooms.



(1) The 2nd floor vanity unit features an illuminated shelf unit at the back and is positioned at a 90° angle. (2) The drawers with soft-close function are easy to use and are a feature of the mobile storage unit and all other furniture. (3) The console basin with console. (4) The built-in basin with console and additional towel rail, 50 cm or 100 cm. (5) Floor-standing bidet and toilet in the Vario version, with visible cistern and connection that fits flush with the wall. (6) Wall-mounted bidet and toilet. (7) Floor-standing bidet and toilet for in-wall cistern.



The 2nd floor furniture range embodies sheer elegance. The tall cabinet, which provides ample storage space behind its mirrored cabinet doors, is shown here in the Rosewood (décor) finish. Light strips at each side ensure optimum lighting. The modular dimensions of the furniture in widths of 40, 60, 80 and 120 cm are carefully thought-out. Each detail of the bathtub is simultaneously chic and practical. The "invisible" outlet, which can be lifted, is concealed beneath an acrylic cover, thus making cleaning incredibly easy. The necessary tool is included. The bathtub is also available with optional waterfall tap.

► Bathtubs and shower trays from p. 172 ► WonderGliss p. 241 ► Overview of furniture finishes from p. 246

STORAGE

The 120 cm-wide washbasin vanity unit offers lots of storage space within its two fully extendable drawers. The matching washbasin is available for one tap fitting or as a double washing area.

GOOD REASONS FOR 2ND FLOOR

- + The concept for live-in bathroom solutions
- + Washbasins with a flat and distinctive form
- + Elegant and high-quality wood tones create a comfortable atmosphere

The room is beautifully furnished; a high gloss white vanity unit with an integrated washbasin and rotating mirrors that hangs from the ceiling. To match the width of the vanity unit, the ceiling panel is available for one or two mirrors or in a 35 x 35 cm square format for one mirror.



For comfort in the bathroom and powder room: Available in myriad dimensions and versions, 2nd floor offers unique solutions, ranging from pure ceramic to vanity unit, large master baths to small powder rooms. (left) The vanity unit that acts as room divider in White High gloss (lacquer) and fully glazed built-in washbasin. (1) Handrinse basin plus all-around wooden panel in the Anthracite Oak finish (real wood veneer). (2) Washbasin with wall-mounted vanity unit. (3) Handrinse basin with floor-standing vanity unit. (4) Washbasin with ceramic semi-pedestal.



FOGO.

With its pure, engaging design and beautiful real-wood finishes, the Fogo bathroom furniture range perfectly combines aesthetics and comfort.

Design by Duravit



Real wood in the bathroom – something that is increasingly in demand by people who want a warm, inviting and comfortable home. The Fogo bathroom furniture range sets precedents in good design. It brings comfort to your fingertips with five real-wood finish options. The consoles, vanity units, tall cabinets, mirror cabinets and mobile storage units not only share their natural real-wood look, but also their sleek, clean lines. Meticulous craftsmanship down to the very last detail ensures enduring beauty.



Vanity units to match the Vero washbasins are available in widths 45 cm to 120 cm.

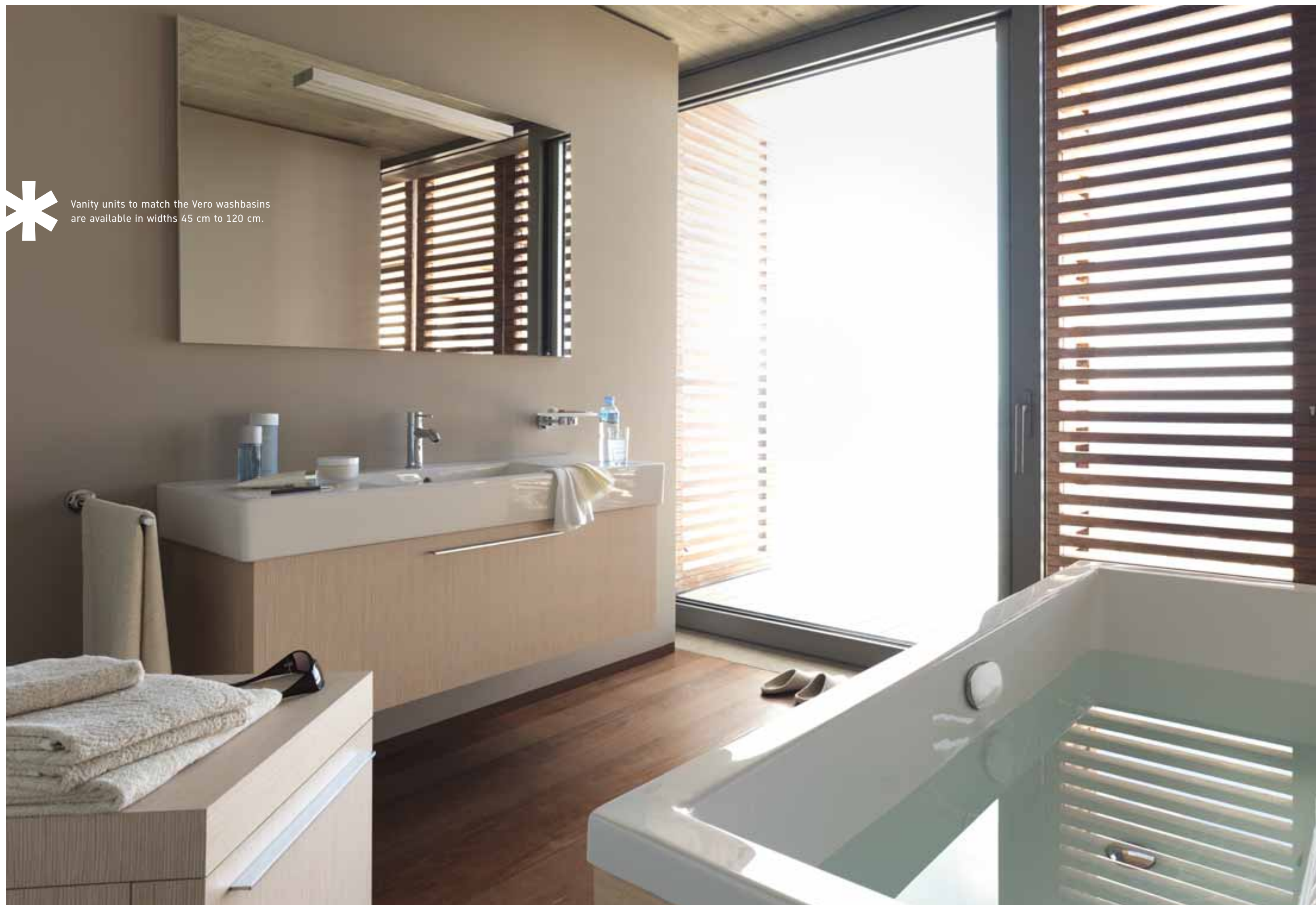

FLEXIBLE

The mobile container with large handle and smooth-closing pull-out compartment and interior drawer.

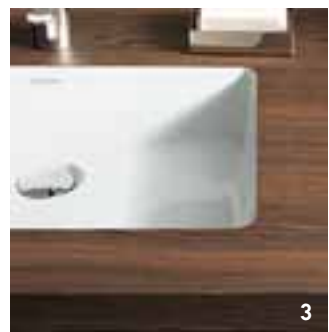

STORAGE

Thanks to the glass shelves, the inside of the 8 cm thick cabinet door offers space for all smaller bathroom toiletries. With dimensions of 176 x 50 x 42 or 23 cm, the tall cabinet proves to be a particularly spacious storage miracle.



(1) The Fogo console can be combined with various washbasins. (2) The Fogo mirror cabinet with surface-mounted light, socket and sensor switch, available in widths 60, 80, 100 and 120 cm The mirror cabinet features a translucent shelf with an integrated indirect light source that illuminates both the inside of the cabinet and the washbasin beneath. A special feature: the distinctive look of the Fogo front is echoed in the mirrored doors. (3) Installing the built-in washbasin from below the console creates a seamless transition from the ceramic to the wooden surface. (4) The vanity units and all Fogo furniture match the consoles and feature distinctive chrome handles.

Variations in real wood: Whether it's warm and inviting American Cherry Tree, dark and sophisticated American Walnut and Macassar or understated Bleached Oak, the four different Fogo finishes offer something for every taste. The Fogo console just 360 mm deep is available with either one or two drawers.

► Bathtubs and shower trays from p. 172 ► Overview of furniture finishes from p. 246

GOOD REASONS FOR FOGO

- + High-quality real-wood finishes
- + Clear and timeless design
- + Compact and organized furniture program



VERO. Consistently rectangular, consistently successful: the Vero range of ceramics is the archetype of minimalist form and a modern classic.

Design by Duravit



Cinema screen or computer monitor, fridge or milk carton, a room, a table, this brochure: our world is inconceivable without the rectangle. Perhaps this is why we are so attracted to Vero: the forms of this ceramic range are entirely restricted to the rectangle. It's a restriction that gives rise to new possibilities: this is why Vero is one of the most versatile ceramic ranges of all time. With minimalist design at its core and the strong support of Duravit's ceramic tradition and expertise, Vero is impressive in terms of its form, function and quality.



1



2



3



4

(1) Minimalist and chic: the rectangular Vero washbasin marks the beginning of a complete range of ceramics, shown here with chrome support frame and designer siphon. (2) Washbasins and handrinse basins are supplemented by an extensive range of toilets. Shown here is the Vero floor-standing bidet and toilets with convenient cistern and automatic SoftClose seat. (3) The Vero urinal with cover makes a hygienic addition to private bathrooms and powder rooms. This, too, adopts the principle of the right angle. (4) The Vero handrinse basin is available in a variety of options and is the perfect problem-solver wherever space is particularly tight.



Vero also offers both functional and attractive solutions wherever space is at a premium.





The spacious furniture washbasins are available in a choice of widths 85, 105 and 125 cm – and with large surrounds.



(1) The form of the right angle is suitable for all room layouts and, thanks to the numerous dimensions, also for smaller rooms, such as the guest bathroom or powder room. (2) Bidet and toilets in wall-mounted versions. The handrinse basin is available in widths 25 to 50 cm and in various options, such as (6) along the wall, with tap fitting at the side and (3) with larger inside basin and a larger storage area. When combined with consoles or countertops, things really start to look welcoming: (4) The Vero built-in basin with tap area is fitted from above. (5) Alternative: The Vero built-in washbasin can be inserted from below into panels made of any conceivable material. (7) The entire collection features the same design lines, just as the Vero bathtub, here as back-to-wall version.



CHIC

The Vero washbasin with chrome support frame and designer siphon. Height-adjustable and with an all-round rail as towel holder.



1



2

BLACK IS BACK

Vero in black high-gloss has a noble, charming and highly modern appeal.



3



4



5

Vero – how to transform 90° angles and 100% Duravit quality into 1000 good washing area ideas. (1) The classic wall-mounted washbasin with extra-large inner basin and raised ceramic wall. (2) The classic wall-mounted double washbasin, pure and simple with a towel holder. (3-5) Vero in on-trend black – looks fantastic with consoles in Oak Anthracite or chrome frames. The resulting bathroom is exclusive and timeless modern.

GOOD REASONS FOR VERO

- + Archetypal
- + Minimalist
- + Versatile, complements every style
- + Sustainable, modern classic
- + The original from Duravit



An attractive alternative to the "classic" washbasin: the Vero console basin with tap panel is glazed on the back and can thus be positioned free-standing in front of the wall or large mirrored surface.

HAPPY D.2

Feminine, chic and archetypal.

Happy D.2 brings a new elegance into the bathroom.

Design by sieger design

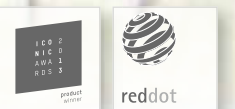

With its clear-cut, architectural design, Happy D. has written bathroom history and thrilled bathroom users all over the world. Happy D.2 is a complete bathroom solution that is just as chic, versatile and timelessly modern as its predecessor – and yet it's also completely new. Because the series presents itself from a feminine side: this is achieved thanks to the fine radii of the rounded corners that feature throughout the bathroom program – and that give Happy D.2 its distinctive, archetypal design. No doubt about it, Happy D.2 brings a new elegance into the bathroom.



Attractive details for living bathrooms: matching accessories of the series Karree.



The washbasin seems to lift visually from the wall, creating an almost floating effect – and this sense of weightlessness features throughout the series. The washbasin is available in the widths 60, 65 and 80 cm.



(1, 2) As stylish as practical: the Happy D.2 furniture washbasin in the version with height-adjustable metal console that also serves as a towel holder. (3) Form and utility: toilets and bidets are available as wall-mounted, floor-standing and back-to-wall options, both with and without the SoftClose seat function. (4) The toilets can also be combined with the SensoWash® Starck shower-toilet seat. More information about SensoWash® from p. 158.



You will find the Happy D.2 bathtubs
on pages 176, 183, 186



TIDINESS

With the optional, intelligent, interior organization system, keeping things tidy couldn't be easier. The partition strips are available in Walnut or Maple.



(1) The delicate wall boards offer practical storage space. They are available in various widths from 60 to 160 cm. (2) Happy D.2 back-to-wall bathtub, 180 x 80 cm with Combi E whirl system. (3, 4) The console basin sits on a matching vanity unit in new brushed Dark Oak finish. (right) The furniture washbasin with matching vanity unit whose curved fronts match those of the washbasin.

GOOD REASONS FOR HAPPY D.2

- + Feminine & chic, delicate & elegant
- + sieger design's new take on an archetype
- + The washbasin and furniture contours are in perfect harmony
- + Décor, real-wood and textile melamine finishes
- + LED technology and optional sound system
- + Particularly high-quality, monolithic-like baths



(1, 2 and left) Textile elegance, deceptively realistic: the new Linen furniture finish introduces a textured and visual elegance into the bathroom – and provides a chic contrast to the white of the ceramic and baths. (3) Bathing in pure geometry: the freestanding bathtub also adopts the sleek radii of the ceramics, which, in combination with the tall-round rim, embody the true essence of what is Happy D.2. Taking a bath is especially comfortable with the optional neckrest.

► Bathtubs and shower trays from p. 172 ► WonderGliss p. 241 ► Overview of furniture finishes from p. 246



STARCK 1.

Philippe Starck's design searches for the origin of things. With his Starck 1 range, he achieved just that... and almost immediately wrote bathroom history.

Design by Philippe Starck



With Starck 1, Philippe Starck and Duravit have returned to the beginnings of hygiene, body care and wellness in addition to the evolution of the bathroom. The Starck 1 toilet, bathtub and washbasin are unmistakable descendants of their historic predecessors – the bucket, tub and washbowl – even though they have been completely reinterpreted. It's great to know that something good doesn't have to be "optimized": since their market launch in 1994, all products in the range – ceramic, furniture, tubs, accessories – have been meticulously crafted by hand using the same methods. This quality is nothing less than you would expect from a modern classic like Starck 1.





The Starck barrel is available in two paint finishes (85 White High gloss and 40 Black High gloss) and in three warm real wood veneers (05 Oak, 13 American Walnut, 24 Macassar).



Matching Starck vanity units make the washing area an elegant centrepiece. Two wooden trays inside the furniture keep the bathroom tidy.



A striking feature of all pieces of furniture is the high-quality aluminium edge with integrated lettering. The conveniently large, handle-free drawers of the vanity units offer lots of storage space. A light tap is all it takes to open the drawer. It is closed with a gentle nudge. The Starck 1 washbasins are available in circular or square design.



With a design that is tailored to the Starck series, the accessories create a complete and harmoniously furnished bathroom.



BEAUTIFULLY SHAPED

The beautifully shaped urinal with cover or without cover is a practical and hygienic option that is also suitable for the private bathroom.

ELEGANT

Washbasin Starck 1 with pedestal or semi-pedestal, available in the widths 75 and 90 cm.



This variant offers lots of room for two and has two square console basins (47 x 47 cm) on one vanity unit. The generous surrounds around the basins hold all kinds of bathroom utensils. The oak real wood surface offers an attractive contrast to the brilliant white of the ceramic. The 170cm high tall cabinet and a rectangular panelled bathtub complete the ensemble.



Design, consequently reduced on the essentials: the washbasin and vanity unit also cut a fine figure as a simple square. The unusual feature is that the tap fitting sits directly in the basin. The chic mirror boasts a characteristic light square – it is available in three widths.

GOOD REASONS FOR STARCK

- + The design classic for all room sizes
- + High-quality and hand-crafted
- + Unique ceramics, narrow ceramic rim
- + Matching bathroom furniture, bath and shower tray program by Philippe Starck



With regard to the new above counter basin the faucet is placed on a sculptural "island". The delicate and slender rim of the basin proofs a revolution in the area of ceramic production. The Starck bathtub with acrylic panel is available in the versions niche, corner and back-to-wall.

► Bathtubs and shower trays from p. 172 ► WonderGliss p. 241 ► Overview of furniture finishes from p. 246



STARCK 2.

Reduced forms,
attractive price. Or
vice-versa. With the
Starck 2 bathroom
range, Duravit
offers high-quality
design in the mid-
range price category.

Design by Philippe Starck



A true Starck, but less elaborate: this was the inspiration behind the second Duravit – Philippe Starck collaboration. The result: Starck 2, a range of ceramics that is the ultimate successor to its famous predecessor, Starck 1. Starck 2 also derives its inspiration from the origins of bathroom design: the ceramic forms embody the flowing movement of water and allow us to see the bathroom through a new set of eyes. Starck 2 – the bathroom as a source.



1



2



DESIGNER GUEST BATHROOM

Indulge your guests in good design: the Starck 2 range is not only highly aesthetic, but also perfectly functional. Despite being a compact 50-cm wide, the handrinse basin still offers plenty of surface space.



3

(1) In the Starck Slimline shower tray, the rim height has been reduced to 20 mm and so appears not only flatter but also more elegant and lightweight. (2) The outstanding detail of the bathtubs is the sloping backrest that opens into a prominent, comfortable neckrest. Here, form and practicality come together to create a truly attractive result. (3, right) The Starck 2 console basin combined with a Starck vanity unit in high-gloss white is as elegant as it is practical.







OVAL

At first glance, the washing bowl Starck 2 appears circular, however, on closer inspection, it is revealed to be slightly oval.



With a design that is tailored to the Starck series, the accessories create a complete and harmoniously furnished bathroom.



Sophisticated in form, diverse in the application: thanks to different dimensions and variants, Starck 2 offers lots of attractive washing area solutions. (1,2) The doors of the mirror cabinet open at the outer edge by 180°. The doors conceal a spacious interior. The freestanding Starck bathtub (5) has long been a design classic and is the perfect complement to the Starck 2 range.

The sides of the Starck 2 toilet are completely closed, with no fastenings – seamless perfection, a feast for design lovers. The toilet is available as a wall-mounted version (1), a floor-standing version with visible cistern (2), a floor-standing version with in-wall-cistern and matching bidet and with the SensoWash® Starck C shower-toilet seat (3+4). More information about SensoWash® from page 158.

► Bathtubs and shower trays from p. 172 ► SensoWash® from p. 158 ► Overview of furniture finishes from p. 246

STARCK 3.

Frequently copied but never matched. The Starck 3 range is and remains the measure of all things when it comes to design, variety and price.

Design by Phillippe Starck

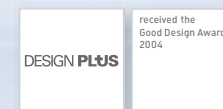

Even more top-quality Starck at a great value: there's no doubt that, with the Starck 3 range of ceramics, Duravit has revolutionized the sanitary world. Starck 3 brings design to a segment where it was once an untouched concept with a vast array of products that meet all needs and tastes. And – the range provides better value for money than ever before. With more than 50 models and 64 variants, Starck 3 is one of Duravit's most extensive bathroom ranges.



THE ORIGINAL

The Starck 3 washbasin derives its distinctive character from the basic rectangular shape, an all-round rim and a low back panel.



With dimensions of just 48 x 46.5 cm, the furniture washbasin with X-Large vanity unit or metal console looks great from any angle. The urinal with target fly encourages a more accurate aim in the guest bathroom (3 - 6).



Whether a spacious private bathroom or a small powder room, the wide selection of products in the Starck 3 range has the right product for any situation. Duravit's extensive Ketho (1) and X-Large ranges (3, 5) with melamine, décor and real-wood veneer fronts in all matching dimensions complement the Starck 3 ceramic to perfection. (2) The built-in washbasin can now be inserted into a Duravit wooden console from below: the transition from the ceramic to the wooden surface both looks and feels seamless – a particularly attractive feature when contrasted with dark woods.



Starck 3 has washbasins in a wide range of sizes and variants and offers something for virtually every ambience, taste and amount of space. The combination with pedestal or semi-pedestal is ideal for purists who want to enjoy the actual form of the ceramic and the material itself without any embellishments.



Where aesthetics meet hygiene. The toilet is an essential part of every bathroom. Reason enough for Philippe Starck to dedicate just as much care to its design as to any other item in the range. The wall-mounted toilet that is closed at the side becomes a distinctive highlight.



Compact Version



The toilet is available in various wall-mounted and floor-standing versions and now also in combination with the SensoWash® Starck shower-toilet seat (1). Like all Duravit toilets, it features a glazed and thus easy-care flushing rim, as well as a 3 or 6-litre flush and dual flush function. The Compact version offers a practical solution for smaller rooms: with a projection of just 485 mm, it saves valuable space in the bathroom (small image).



DURASTYLE.

The new standard
in the bathroom.
Individuality
is important in
everyday living.



Design by Matteo Thun & Partners



However, individuality does not mean making an impression with all means. Simply an ambience which reflects itself, gives your personality air to breathe and space to do your own thing. Such as DuraStyle: Designed by Matteo Thun & Partners, the range of bathrooms is revealed as deliberately discreet – and blends harmoniously into practically any ambience for this very same reason. Two surface versions – light and dark – open up further options for individual bathroom design. Simply incomparable in its formal simplicity, DuraStyle succeeds with ease in underlining the personality of the bathroom user.



REDUCED

The beauty of reduction: The washbasin is convincing with its deliberate visual restraint.



MIX

The trick is in the mix between open and closed areas. In this way, everything works airily and transparently. The refined 2/3 division of the wall unit is also continued with the vanity units.

(1) The bathtubs trademark is the characteristic upstand on the back edge of the tub: it creates a sense of order, since the shampoo etc. simply disappears behind it, and also can be used as a support to make it easier to get in and out. (2) DuraStyle as a console basin solution, 43 or 60 cm wide, combined smartly with a vanity unit, 100 or 140 cm wide – everything is highly flexible. Another option: The accommodating built-in washbasins in 43, 60, 60.5, and 56 cm wide drop-in versions. (3) Although it offers plenty of shelving area, the washbasin works quite easily, thanks to its narrow edge. The eye perceives less material, which also provides calm and clarity in smaller spaces. The overall impression that it is almost weightless is supported by the solid timber accessories, here in oak in the floor-mounted version, pure or contrasting with the shelf in matt white (4).





SIMPLICITY

With a range of vanity units, the washbasin meets all requirements.



1



3



2



ELEGANT

Unusually flat, unusually elegant: Toilet seat and lid form the visual continuation of the narrow edge.

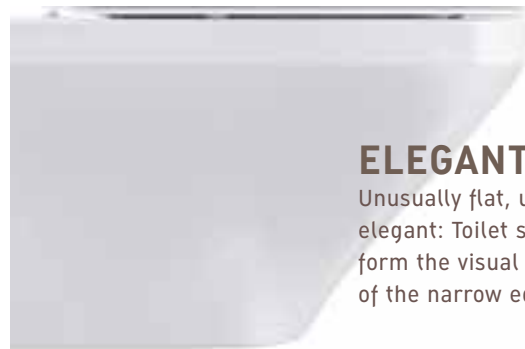

4



5



6

(1 and 2) With the mix of open and closed surfaces, the furniture makes a light and airy impression. (3) The freestanding bath promises a wealth of bathing pleasure while taking up minimal space. (4 and 5) The innovative impression given continues with the shapes of the toilet and bidet: The flat lid/seat combination, available with and without a soft-close system, is eye-catching. Toilet and bidet are available in wall-mounted, free-standing and back-to-wall versions, supplemented by a one/two piece toilet. DuraStyle also offers innovative solutions for bathtubs. (6) DuraStyle bathtubs are available with acrylic or furniture surrounds and optionally with a whirl system or price competitive "Jet-Project" system.

GOOD REASONS FOR DURASTYLE

- + Simple, yet formal design
- + Design by Matteo Thun & Partners
- + Price-conscious, versatile, perfect for any taste
- + Narrow bathtub rim with distinctive edge
- + Comfortable basin depth
- + Furniture solutions with a distinct lightness; a mix of open and closed fronts
- + Exciting combinations: light and dark décor wood tones
- + Handleless doors and drawers
- + Rimless toilet with easy-care rim and hygienic flush
- + Super-flat toilet seats
- + Bathtub with sleek, practical rim



► SensoWash® from p. 158 ► Bathtubs and shower trays from p. 172 ► Overview of furniture finishes from p. 246



ARCHITEC. The basic architectural elements – the circle and the square – were the inspiration behind the Architec sanitaryware range, which is ideal for a wide variety of applications.

Design by Prof. Frank Huster



Washroom hygiene is the result of visual appeal and practicality. Developed by Prof. Frank Huster, the Architec ceramic range is compliant with philosophy. The circle and square: two basic architectural elements that sufficed in creating a straight-lined, modern, abundant product range for almost any intended use, whether private, public or barrier-free.

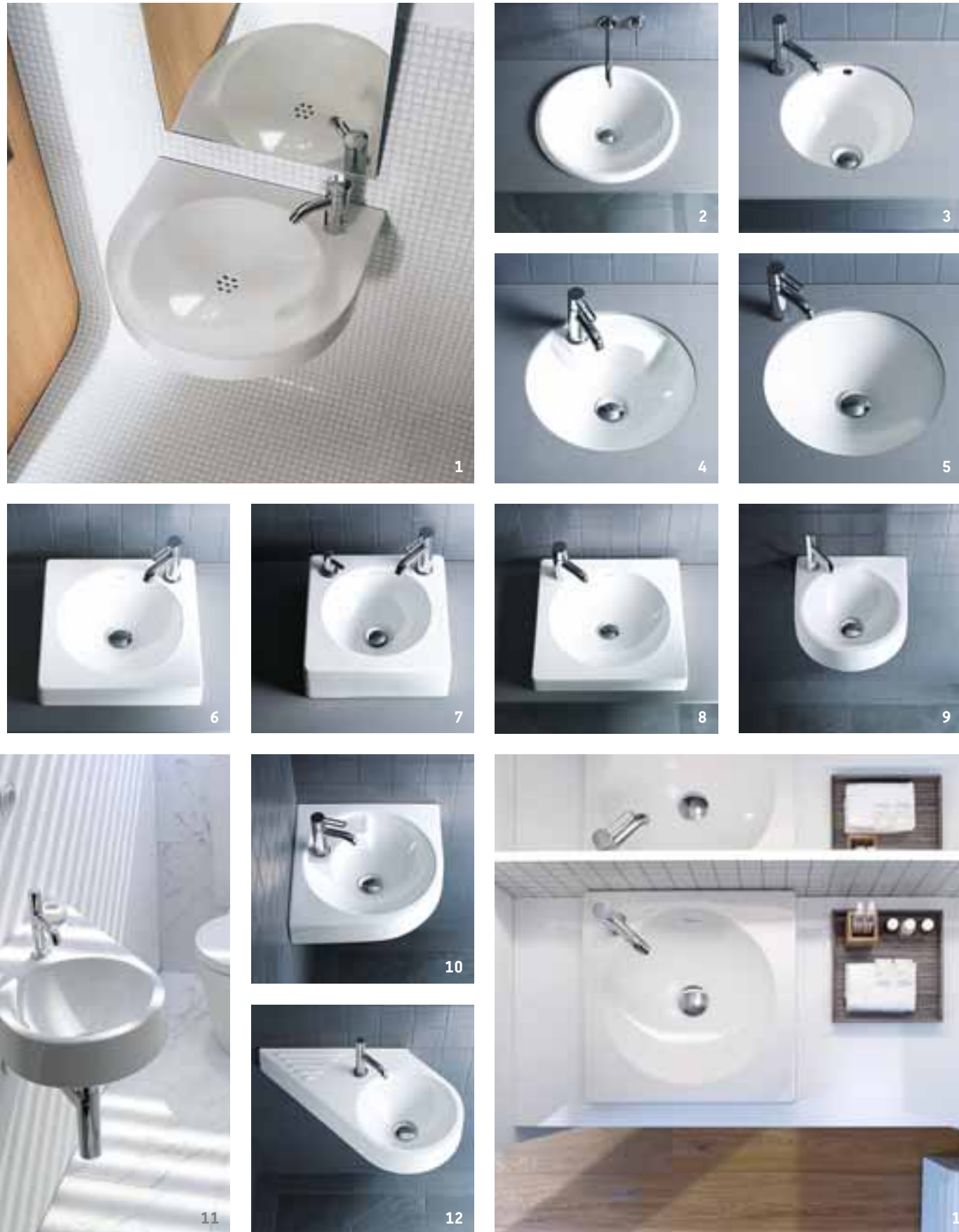

A design idea that has a tremendous impact in a wide variety of different forms: (1) The washbasin is wheelchair-friendly. (2) Built-in washbasin from above. (3) Built-in washbasin with overflow. (4) Built-in washbasin with integrated tap panel. (5) Built-in washbasin without overflow. (6) Console basin 45 cm. (7) Console basin with integrated soap dispenser. (8, 13) Console basin 50 cm. (9) Handrinse basin 36 cm wide. (10) Corner washbasin. (11, 12) The unusual diagonal cut of the Architec washbasin allows not only a generous storage surface but also more space in a smaller area.



The Architec wall-mounted toilet and wall-mounted bidet with the new Durafix attachment is quick and easy to install and also completely invisible.

► WonderGliss p. 241 ► Bathtubs and shower trays from p. 172

Version with classic rim

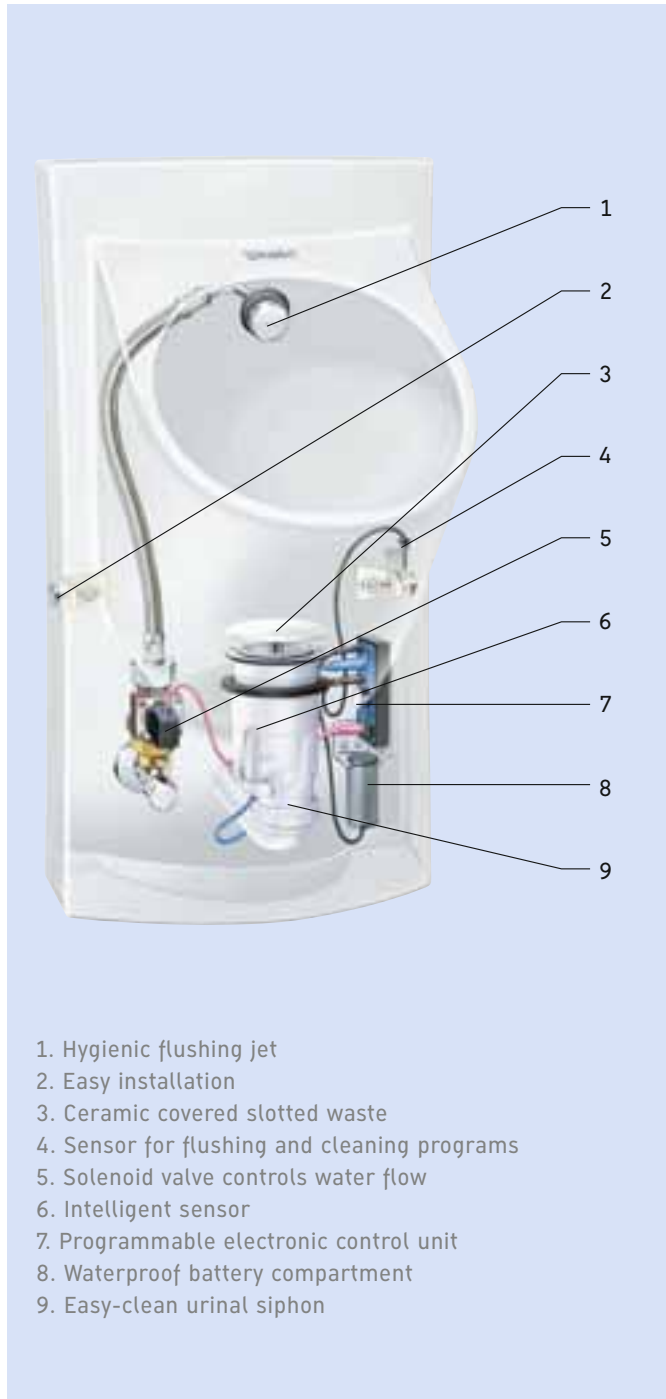

The intelligent urinal from Duravit. Flexible, hygienic, comfortable, vandalproof: The Architec urinal paves the way for the future of public and semi-public areas.



- 1. Hygienic flushing jet
- 2. Easy installation
- 3. Ceramic covered slotted waste
- 4. Sensor for flushing and cleaning programs
- 5. Solenoid valve controls water flow
- 6. Intelligent sensor
- 7. Programmable electronic control unit
- 8. Waterproof battery compartment
- 9. Easy-clean urinal siphon

Originally developed for public areas, Architec shows what it's made of: the "intelligent" urinal is available with classic flushing rim (1) or with flushing jet and easy-to-clean rim (2), with water inlet either from above or behind, or in a programmable electronic version. The form of the urinal proves particularly easy to clean. Extra practical for the operator: the interior siphon cartridge can be replaced quickly and easily from the front without dismantling the urinal. For all Architec urinals: District surveyor approval required.

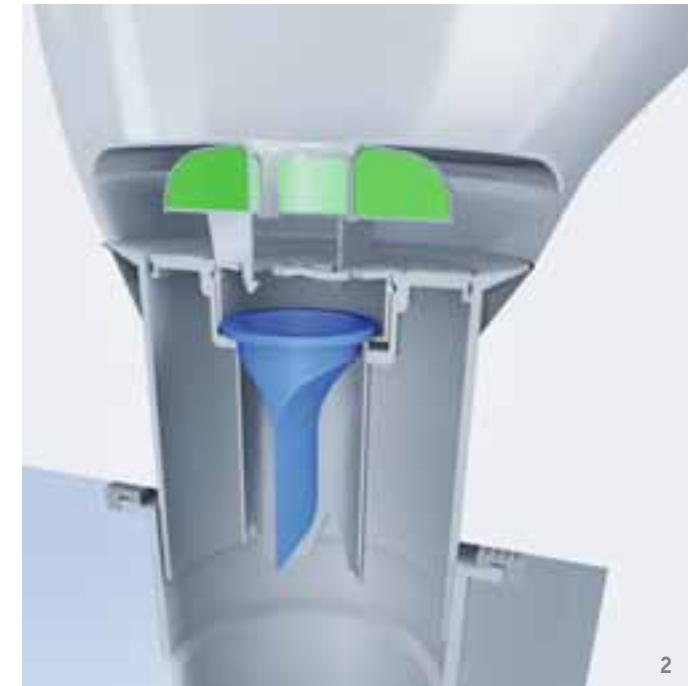
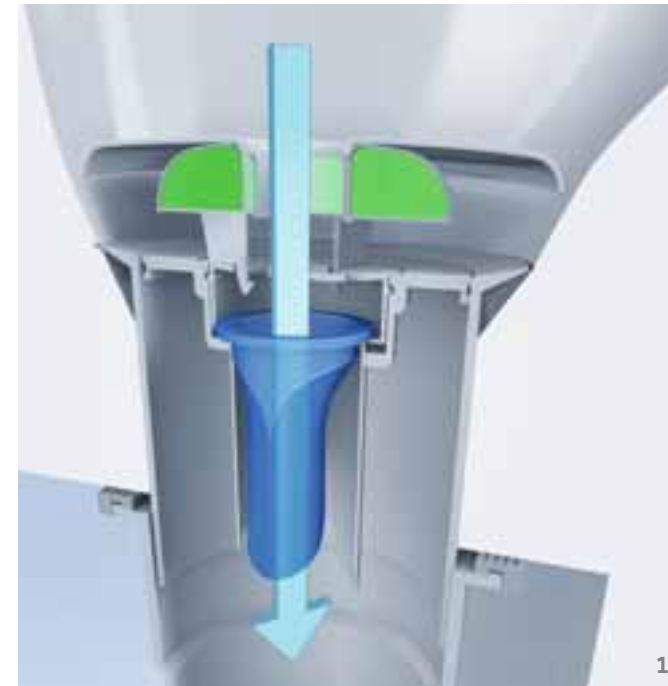

Architec Dry. The new dry urinal from Duravit, flushes without any water whatsoever, making an important contribution to the environment. The secret is a hose diaphragm integrated into the outlet that only opens when urine flows through. (1) and then closes again (2) – it operates automatically, is odour-proof and concealed behind an attractive cover with scented ring. Alternatively, the urinal is also available without a cover. Maintenance of Architec Dry is child's play: the diaphragm has to be replaced as soon as the green, biodegradable gel in the fragrance ring has completely dissolved. A separate key is used to replace the relevant module with bayonet fitting (3-5).



SCOLA

Scola began its career in the classroom. Today, the washbasin is at home with people who value icons. In fact, Scola is the washbasin that has remained unchanged and included in the Duravit program the longest. It is popular, for example, in the private bathroom or utility room: the circular, deep inside basin offers lots of space to wash one's hands and the ceramic surrounds offer lots of storage space. The version with chrome support frame (small image) is a chic alternative to the wallmounted washbasin.



BAGNELLA

And now for something completely different: taking the traditional washbowl as its starting point, sieger design created this Bagnella basin – circular, simple and already a timeless classic. The form of the console basin remains completely unadorned, while a broad, all-round rim serves as its striking feature. Bagnella can be combined with all types of consoles and countertops. The small chrome ring (small image) that accompanies the basin provides an elegant connection and also facilitates cleaning.



BACINO.

With the Bacino console washbasin, Duravit set a trend that continues unabated today.



Design by Duravit

A small but attractive range, Bacino enables both modern and distinctive washing area solutions for private bathrooms, powder rooms and hotels. Bacino can be combined with the Fogo furniture range, as well as with other console materials, such as stone, concrete or glass mosaic. (small images) The console basin in the "rectangular" variant with softened corners with furniture console or as attractive double washing area solution.

X-LARGE.

A tremendous amount of storage space and endless possibilities for bathroom design – without appearing weighty.

Design by sieger design

The name says it all: Offering plenty of extra storage space and extra elegance, the X-Large furniture series is popular with instinctive good taste. And they can now develop this even further with the X-Large series, which Duravit now has completely re-interpreted. Great in terms of function but even more sophisticated in terms of form. Stylistic individuality and maximum flexibility are made possible thanks to a wide variety of widths, two depths and eight different furniture finishes. With elegant proportions and exquisite design, X-Large creates a sense of weightlessness, thus reflecting the spirit of the times.



1



2

LET THERE BE SPACE

The X-Large tall cabinet has amazing storage capabilities. Just 36 cm deep, it is available in three different widths. The glass shelves can be easily removed for cleaning.



4



3

Everything in its place. The new X-Large collection offers a tremendous amount of storage space for bathrooms of every size. Whether wall board (1), tall cabinet (2), console (3), wheeled container (4), vanity unit or semi-high cabinet (right) – everything is presented in an extra elegant and modern look. Inside the furniture, clever storage boxes help to keep things tidy. A tremendous amount of storage space plus a timelessly modern design: in this way, X-Large scores points with all pragmatic bathroom users with instinctive good taste.



A bathroom that knows how to shine:
X-Large in White High Gloss finish.





NICHE SOLUTION

Flexible: with a variable width of 80 to 200 cm, the X-Large consoles showcase the width of large rooms to optimum effect but are just as suitable as niche solutions for hotels or small rooms.



1



2

CAPPUCCINO HIGH GLOSS

(below and right)
Stylish comfort: the X-Large furniture in Cappuccino High Gloss finish (lacquer).



(1, 2) Good ideas for small spaces: X-Large offers a surprising amount of storage space, even in smaller guest bathrooms or hotel rooms. Consoles and vanity units in two depths (55 and 48 cm) are ideal for combination with an even larger selection of washbasins. In addition, the console is available without cut-out and in a variable length of 800 to 2000 mm. As a result, back-to-wall, corner and niche solutions pose no problem whatsoever!





MUSIC INSIDE

The mirror cabinet is optionally available with an integrated sound system that streams music to offer a soft, clean sound and a surround-sound audio experience.



SEAT

Dual purpose: the mobile storage unit provides space for bathroom utensils and also offers a comfortable seat for relaxing.



Bathtub panels in Brushed Oak finish are available for Vero, Starck and Paiova bathtubs.



X-Large vanity units and consoles come in two depths: in 55 cm and in narrow 48 cm – particularly useful for small rooms. The program is not only extra spacious but also extra versatile. Eight different finishes ensure maximum individuality, whether particularly natural in Dark Chestnut (décor) (top) or particularly refined in Oak Anthracite (real-wood veneer) (below).

The new Brushed Oak real-wood veneer has a particularly natural feel. All finishes are also available for the X-Large mirrors and mirror cabinets, which are capped by an elegant light canopy. The spacious mirror cabinet boasts LED technology (illumination 300 Lux, color temperature 3500 kelvin) with a reference size of 80 mm wide, dimmable as an option. It is also optionally available with the new sound system.

GOOD REASONS FOR X-LARGE

- + The updated and comprehensive bathroom furniture program by sieger design
- + Super-flat console design
- + Flexible and modular
- + Variable dimensions for large and small bathroom solutions
- + Consoles and vanity units in two depths (55 and 48 cm)



The X-Large bathroom in Natural Walnut (décor), with bathtub panel, shown here: the bathtub Vero.



NATURAL WALNUT

The new Natural Walnut (décor) finish creates a sense of comfort with a natural, authentic feel.



With the super-flat consoles (12 + 12 mm), the lower panel is set back to reinforce the floating effect. Thanks to the shadow gap between the panel and body, the vanity units also appear very lightweight and this effect is further highlighted by the narrow, chic aluminium handles. The mix of open and closed fronts ensures even a greater lightness and transparency.

► Bathtubs and shower trays from p. 172 ► Overview of furniture finishes from p. 246



KETHO.

Comfortable, modern, versatile and good value for money, Ketho becomes the ideal range for first-time buyers.

Design by Christian Werner

These demands also extend to the bathroom, which we expect to be attractive, inviting and also functional. Ketho takes this development into account: designed by Christian Werner, the new range of bathroom furniture is characterised by clear forms, well thought-out functionality and comfortable quality. The characteristic, ergonomic handles feature throughout the range and give Ketho its true originality. The reduced look of the range is flexible enough to suit any modern bathroom ambience. Combined with good value for money, Ketho becomes the ideal range for first-time buyers.

A horizontal strip light is integrated into the Ketho mirrors for optimum, non-glare lighting. Available in five widths, one of these without light.





THE TALL CABINET: A STORAGE SPACE MARVEL

The tall cabinet – here shown in graphit matt – is available in three different heights (88, 132, 180 cm).

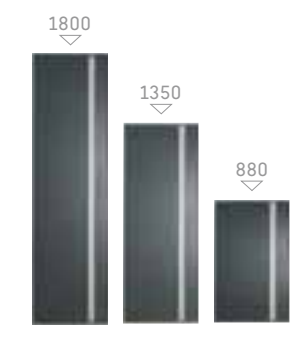

Everything in its place: the Ketho mirror cabinet (1), here in basalt matt, offers a generous interior for bathroom utensils. The lights are positioned vertically along the sides. It is available in four widths (65, 80, 100 and 120 cm) with one, two or three doors and with optional handles. Additional practical storage space is provided by the vanity units, shown here with the D-Code (2) furniture washbasin and the mobile storage unit (3).



(1-3) Inviting and comfortable, in the powder room, too: the Ketho vanity units – here in white matt – can be combined with washbasins from the Darling New, Vero and Starck 3 ranges. One furniture type, lots of possibilities: the console washbasin and countertop washbasins that can be fitted in the vanity unit from above (4, 6) allow various combinations with lots of storage space. If the washbasin is inserted into the furniture from below (5), the transition from the ceramic to the wooden surface both looks and feels seamless, which makes it particularly easy-care.

GOOD REASONS FOR KETHO

- + Top furniture design at an unbeatable value for money
- + On-trend ergonomic aluminium handle
- + Many different combinations
- + Pleasantly matte furniture finishes



The characteristic Ketho handles not only feature impressive workmanship and feel comfortable to the touch, they also create a visual impact: the horizontal and vertical lines highlight the length of the furniture, making it appear more streamlined and elegant. Ketho is ideal for combination with the furniture washbasins in the Starck 3, Darling New and Vero ranges. The tall cabinet is available in three different heights (80, 132, 180 cm).

► Bathtubs and shower trays from p. 172 ► Overview of furniture finishes from p. 246



1930 SERIES.
Unashamedly
nostalgic and yet
timelessly modern:
its octagonal
design makes the
1930 Series a
bathroom classic.

The Duravit product range would be incomplete without this classic, which was designed in the Golden Era and presented to the public for the first time in 1930. Over time, many charming pieces were added to 1930 Series to create the complete collection as we know it today.



GOOD REASONS FOR 1930 SERIES

- + The classic for powder rooms and bathrooms
- + Timeless design
- + Suits modern, classical and elegant bathrooms



NOSTALGIC

The washbasin from the 1930 Series with its characteristic octagonal design.



(1) And yet, however consistently classic its look, 1930 Series epitomizes cutting-edge technology — as exemplified by its wall-mounted bidet and toilets. (2) Bidet and toilets in the floor-standing version with ceramic cistern, available with 6-liter and dual-flush system. (left) The washbasin shape is the archetypical octagon, with sides that taper downwards.

► WonderGliss p. 241 ► Bathtubs and shower trays from p. 172

The new opulence in the bathroom: like a chaise longue, the bathtub from the Esplanade range invites the user to lie back and relax. With tremendously generous dimensions of 1910 x 1045 mm, it promises a truly regal bathing experience.



ESPLANADE –
luxurious, spacious,
visually impressive
and modern.
Tchoban deliberately
plays with the
splendour of times
past but not forgotten.

Design by Sergei Tchoban



As an architect, he is internationally successful. He designed the Federation Tower in Moscow, which is the highest skyscraper in Europe and the Aqua-Dom in Berlin, the largest free-standing aquarium in the world. Sergei Tchoban has now designed a bathroom range for Duravit: So it's no coincidence that the floor-standing toilet resembles an ancient chair, the washbasin a chest of drawers and the bathtub a chaise longue. The Esplanade furniture is available in two completely different looks, either in exquisite silk or the comfortable oak wood panelling.



Thanks to the oak panelling, the entire bathroom seems to become part of the living area. An attractive detail on the tall cabinet and vanity units is the high-quality leather handle for opening the doors and/or drawers (top). Generous dimensions: the washbasins are 600 or 850 mm wide, and the floor-mounted toilet and bidet have a projection of 650 mm. The mirror that is illuminated on all four sides offers optimum lighting (right).





In the silk surface finish, Esplanade is stylish, refined and timeless. However, practicality is just as important as looks: with a dark brown leather handle, the tall cabinet and vanity units offer lots of storage space that, in the drawers, is divided into practical compartments. Modern opulence that makes living bathrooms considerably more comfortable.



► Bathtubs and shower trays from p. 172 ► WonderGliss p. 241 ► Overview of furniture finishes from p. 246



BATHROOM_FOSTER.

When a top architect and designer designs a bathroom range, it's normal to expect something really special – like Bathroom_Foster.



Design by Norman Foster

Is it design or is it architecture? In any case, it is genuine Foster. Sensational, like all his work: Stansted Airport in London and Chek Lap Kok Airport in Hong Kong, the Hongkong and Shanghai Bank and the new German Reichstag. Once again, the architect and designer Norman Foster has excelled himself and created a bathroom that pushes the boundaries, which defines the bathroom anew. Bathroom_Foster. Made by Duravit.



CARO.

When purity becomes an experience: reduced forms and a distinguishing sweeping movement make the Caro ceramic range ideal for elegant bathrooms.

Design by Phoenix Design

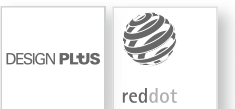

In these times dominated by a striving for "more, faster, brighter, louder", when experience is measured in terms of quantity rather than quality, it is good to witness a design idea which wins through on the strength of pure clarity. Caro uncompromisingly shuns everything which is superfluous to requirements, drawing its inspiration from the motion and color of water. A restrained approach provides for expansive results. The washbasin countertop is as large as possible, because the bowl is only as large as necessary.



(left) Consistency with the built-in washbasin, too: small basin with lots of surrounding space. (1) The washbasin is available in widths of 60 cm, 70 cm and 90 cm, with a ceramic pedestal or semi-pedestal. (2) Wall-mounted bidet and toilets, the latter of which features water-saving 6-liter technology. (3) Ideal for the guest bathroom and powder room: thanks to the slim-line dimensions of the handrinse basin with semi-pedestal, all available space is used, regardless of its compact size. (4) The floor-standing toilets with ceramic cistern and inner plastic tank is particularly quiet and creates almost no condensation. It is a particularly ideal solution for warmer climatic regions.

1-Piece and 2-Piece TOILETS



One-piece toilets: (1) Darling New #2123010005. (2) D-Code #01130100001. (3) Vero #2103010005 (4) Starck 3 #2120010001 (5) DuraStyle #2157010005. (6) Happy D.2 #2121010000. (7) Starck 2 #2133010005 (not shown) Darling New #2123510005. Starck 2 #2133510005. Starck 3 #2120510001. **Two-piece toilets:** (8) Darling New #2126010000 + #0931200005. (9) Happy D. #0112010062 + #0929100005. (10) 1930 Series #2130010000 + #0872300005. (11) Caro #0101010062 + #0924100005. (left) DuraStyle #2160010000 + #0935200005. (left) Starck 3 #2125010000 + #0920400004. (not shown) Darling New #2126510000 + #0931200005. Starck 3 #2125510000 + #0920400004.

► Wondergliss p. 241

sensoWASH®

SENSOWASH.®

SensoWash® shower-toilet. For that freshly-washed feeling.



The development of a sophisticated technology makes it possible to shift all the connections and technology for the toilet seat into the "interior" of the toilet ceramics. This makes installation simple and effortless.

Design by Philippe Starck

Nothing is as thorough, as hygienic, as natural and as refreshing as cleaning with water. Also after using the toilet: This is why Duravit developed SensoWash® Starck, a pioneering innovation in the world of shower-toilet seats that redefines comfort, quality of life and modern toilet hygiene, from gentle cleaning to pleasant drying, all operated by a remote control. SensoWash® is available in three comfort classes and compatible with toilets from the Starck 2, Starck 3, Darling New, DuraStyle, Happy D.2 and D-Code series. Would you like to find out more? www.sensowash.com



Double safety, thanks to Probox. In order to comply with the requirements of DIN EN 1717 on the protection of drinking water from contamination, Duravit has developed a two-tier safety system for SensoWash®. First, the toilet seat has two built-in backflow preventers, one in the connection hose and one in the connection supports. Second, Duravit provides an additional safety device: the Probox. This is installed outside the seat. This way, Duravit fulfills all possible safety requirements that could be set for a product.



When developing SensoWash® Starck, the focus was very firmly on design: Its designer credentials are evident in the timelessly modern character of its elegant, slimline aesthetics. The extra-slim design shows the high formal requirement placed on it and the timeless modernity, ceramic and seat merge to form a harmonious, elegant unit. Irrespective of whether SensoWash® Starck is combined with the toilets from the DuraStyle (1), Happy D.2 (2), Starck 2 (3+4), Starck 3 (5+6) or Darling New (7) ranges.





The SensoWash® shower-toilet provides gentle cleaning. New: with concealed connections.



From the comfortable, heated seat to the wireless, intuitive remote control SensoWash® Starck feels every bit as good as it looks. The functions themselves – rearwash (1), comfortwash (2), ladywash (3), warm air dryer (4), profile storage for two users – offer maximum comfort and ultimate user-friendliness.



sensoWASH®

Anyone can paint, but to create art is to create a tasteful yet diverse whole out of a few related color tones. The next page is an example of the many variations that are possible with „non-colorful“ tones like white, natural, anthracite and black. Maybe they will help to inspire the design of your new bathroom?

YOU
SET
THE
TONE.

All White

And not a chill in the air: the Vero bathroom showcases the purest of all colors. The light flooded room creates a friendly and inviting atmosphere. The bathroom furniture creates a truly glamorous appearance with a white, high-gloss finish, while soft accents solidify the combination with matt furniture surfaces.

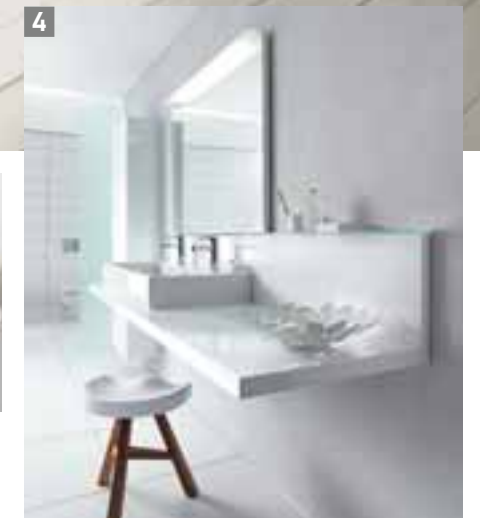

1 A combination of high-gloss and matt: the Ketho bathroom furniture series in white matt, combined with the Vero ceramic series. Light grey walls, finished white board. Find out more about the Ketho bathroom furniture series on page 132. **2** Vero wall toilet and wall bidet, more information on the series starting on page 60. **3** Vero furniture washstand with high-gloss white X-Large furniture base. Find out more about the X-Large series starting on page 122. **4** Delos console in White High Gloss (lacquer) and double furniture washbasin of the Vero range.



NATURALLY PURE

Anything but dull: This Vero bathroom skillfully combines white and light grey tones into a coherent whole. Especially warm and cosy, the surfaces of the furniture are limed oak. Choose a basalt matt surface if you would like to give the room a cooler touch. Either way, you will have a chic and modern bathroom to enjoy.



1 Vero furniture washstand with chrome console. 2 Wash space solution with Fogo in limed oak and two Vero washstands. Find more about Fogo starting on page 52. 3 Vero wall toilet and wall bidet, in white (alpine). 4 Washstand assembly and mirror Ketho in basalt matt, both 1000 mm, combined with a Vero washstand installation. Beautiful contrast: medium grey walls.

GREY ZONE

Highly aesthetic grey zone: Anthracite tones are as elegant as they are inconspicuous - and probably why they are so timelessly fashionable. Anthracite bathroom furniture is an optical upgrade for your bathroom and is enhanced even further by matt aluminium grip rails. White ceramic and light grey surfaces make for an effectively proven combination.



1 Asymmetric wash space with Ketho in graphite matt. Beautiful contrast: Vero washstand in white (alpine) with medium grey walls, floor in smoked oak. 2 Happy D.2 furniture washbasin 800 mm with matching vanity unit and semi-high cabinet in linen (décor). 3 Vero furniture washstand in 3 sizes, 1250 mm, 1050 mm and 850 mm.



BLACK IS BACK

White is not always the answer. Trend researchers foresee black as the color of the decade. No wonder: Vero in black high-gloss has a noble, charming and highly modern appeal - and it superbly unites with oak anthracite bases or chrome consoles. All of this creates an exclusive - and timeless yet contemporary - bathroom.



1 Vero washbasin with new dimensions: 1200 mm wide and chrome console. 2 Bathroom furniture series X-Large in oak anthracite. 3 Vero washbasin for one or two wash spaces. 4 Original guest toilet: material mix with medium grey, a warm oak tone and Vero in high-gloss black. 5 Ketho in graphite matt with black, high-gloss Vero ceramic. 6 Toilet and bidet combinations from the Vero series.

DURAVIT CUCINA.

Appetizing, durable
and individual.
Ceramic sinks by
Duravit.



Starck K



Vero



Kiora

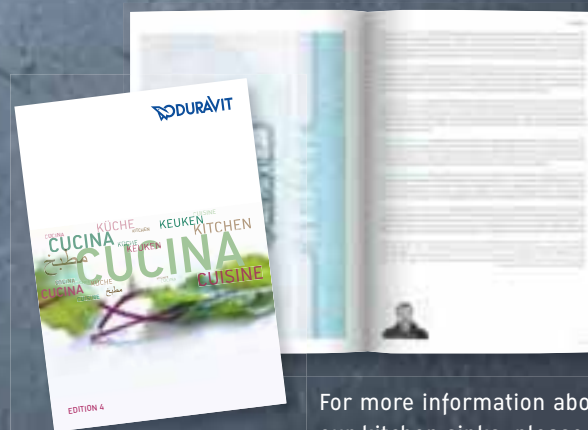

For more information about our kitchen sinks, please refer to the Cucina brochure that can be ordered free of charge and is also available to download from the Service area at www.duravit.com/cucina



Ceramics for the kitchen. The kitchen is familiar territory for Duravit. It started to manufacture crockery as early as 1817. With the Cucina range of ceramic kitchen sinks, Duravit has come full circle and is introducing an accomplished combination of form, function and durability to the kitchen. The work of high-profile designers. Carefully manufactured with the new, patented and highly robust DuraCeram® ceramic mass. Boasting lots of useful attributes. And featuring the high quality customers have come to expect from Duravit. Would you like to find out more? Further information is available from the high-quality kitchen retail trade or at www.duravit.com/cucina



YOUR VERY OWN HOME SPA

Wellness for body and spirit, for the mind – and for the home: we hope you enjoy Duravit's bathtubs and wellness systems.



It may sound banal, but we want you to feel completely comfortable and relaxed, whenever possible – and we don't want you to have to go find a public spa to achieve this. Rather, we want you to enjoy relaxation and comfort at home, in your own bathroom. This is why Duravit has developed bathtubs and wellness systems that leave nothing to be desired – neither in terms of function nor form. Like all Duravit collections, the bathtubs and wellness products comprise high quality materials, workmanship and functional finesse while exemplifying our inherent and intuitive feel for good design.

FREESTANDING BATHTUBS

From page 176



BACK-TO-WALL BATHTUBS

From page 180

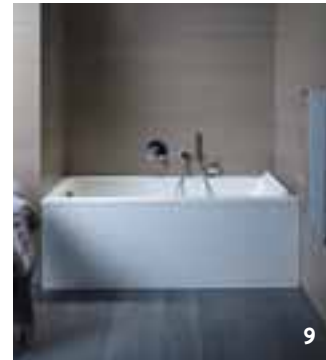

BUILT-IN BATHTUBS

From page 186

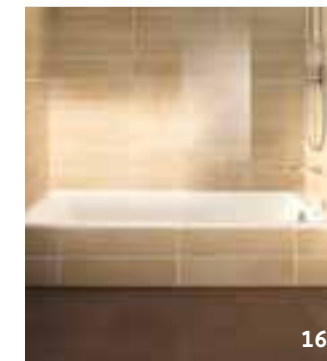

CORNER BATHTUBS

From page 188



Freestanding bathtubs. The eye-catcher at the centre of the room: a freestanding bathtub from Duravit really comes into its own wherever there is plenty of space. (1) DuraStyle 140x80 cm, (2) PuraVida 200x100 cm, (3) Starck 180x80 cm, (4) Esplanade 191x104 cm, (5) Starck 190x90 cm, (6) 2nd floor 170x75 cm, (7) Happy D.2 180x80 cm. **Back-to-wall bathtubs.** Perhaps the most beautiful thing to be paired with a wall: a Duravit back-to-wall bathtub, available in many different forms, finishes and versions. (8) Vero 180x80 cm, (9) Starck 170x75 cm, (10) Starck 200x100 cm, (11) Darling New 190x90 cm, (12) 2nd floor 190x90 cm, (13) Happy D.2 180x80 cm, (14) Esplanade 210x90 cm.

Built-in-bathtubs. We design the bathtub, you choose the trimmings: an attractive built-in bathtub from Duravit is the logical choice for all creative interior design ideas. (15) Starck 190x90 cm, (16) DuraStyle 170x75 cm, (17) Daro 170x70 cm, (18) 2nd floor 170x75 cm, (19) Darling New 170x70 cm, (20) PuraVida 200x100 cm, (21) Happy D.2 180x80 cm. **Corner bathtubs.** The corner bathtubs from Duravit make maximum use of the space in the bathroom. (22) 2x3 190x90 cm, (23) Darling New 141x141 cm, (24) Esplanade 190x90 cm, (25) Paiova 180x140 cm, (26) Darling New 190x90 cm, (27) Paiova 170x100 cm, (28) Paiova 170x130 cm.



Happy D.2 bathtub with acrylic panel, 180 x 80 cm and optional neckrest.



Not just pleasing to the eye: the minimalist Starck bathtub with panel, 180 x 80 cm, introduces new purity to the bathroom. Like all Duravit bathtubs made of high-quality sanitary acrylic, its warm surface feels pleasant to the touch, creating a feeling of relaxation right from the start.



Sound via Bluetooth

A new sound module is a melodious option for all Duravit bathtubs: It uses Bluetooth to establish a connection with an MP3 player, mobile phone, etc. More information on p.195.



(1) Freestanding Starck bathtub as two-seater with acrylic panel, 190x90 cm. Flexible optics and features. (2) With tremendously generous dimensions of 191 x 104 cm, Esplanade bathtub promises a truly regal bathing experience. Shown here with the welcoming panel in oak (real wood veneer). Taking a bath is especially comfortable with the optional soft neckrest. (3) Freestanding PuraVida bathtub with acrylic panel, 200x100 cm. (4) The bathtub of the 2nd floor range comes in different dimensions, from 170 x 70 cm to the two-seater with 200 x 100 cm, here shown in ebony wood finish.



The freestanding DuraStyle bathtub promises lots of bathing pleasure despite the compact external dimensions (140x80 cm), shown here in Chestnut Dark. Further bathtubs, please see page 185.



Coordinated luxury. With Paiova Monolith, the striking inside basin is part of an overall rectangular form that creates additional storage space with minimum water consumption and maximum bathing pleasure. It is extra comfortable thanks to the optional headrest.



Vero bathtub 180 x 80 cm with acrylic panel.

White, an enduring fashion favorite: Duravit is now offering bathtub models with panel made of sanitary acrylic – glossy snow white, elegant and attractive. Available for Vero (top), 2nd floor, the rectangular Starck bathtub, Paiova, DuraStyle and Darling New.



Darling New bathtub with acrylic panel, 180x80 cm.



Bathing in pure geometry. The slim, rounded corners featured throughout the Happy D.2 series give it its distinctive, archetypal design. Here the back-to-wall bath 180 x 80 cm with moulded acrylic panelling (1).

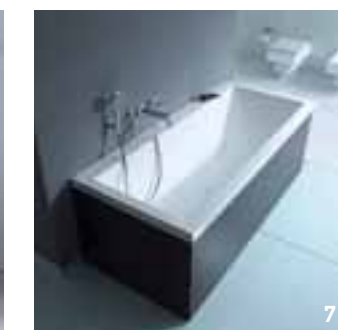

(2,3) The characteristic recess of the PuraVida bathtub (180 x 80 cm) is available with acrylic panel in aluminium or with soft shimmering LED lighting. (4) Taking a bath together can be fun, and also really comfortable. The Starck bathtub, 200 x 100 cm, with two sloping backrests and American Walnut (real wood veneer) bathtub panel. The Darling New bathtubs offer attractive and effective wellness: shown here with welcoming wood panel in Pine Silver (6) and as acrylic panel version (5 and left). (7) As with the rest of the range, the rectangle of the Vero back-to-wall bathtubs is an eye-catching design feature. They are available in four sizes, from 170 x 70 cm to 190 x 90 cm.



Esplanade – luxurious, spacious, visually impressive and modern. Here as a back-to-wall version with panel made of white sanitary acrylic. The Esplanade range of bathtubs comprises a freestanding, back-to-wall and two corner versions, either with furniture or acrylic panel.



Outstandingly different. An intuitive feel for details has also gone into the modification and modernisation of the Starck bathtubs. The outstanding detail of the bathtubs is the sloping backrest that opens into a prominent, comfortable neckrest. Here, form and practicality come together to create a truly attractive result. With optional neckrest. DuraStyle also offers innovative solutions for bathtubs. The characteristic slope of the rear edge serves as a hand rail for easier access while also adding to the tub's visual appeal. The raised edge also creates a practical storage space for bath accessories. DuraStyle bathtubs are available with acrylic or furniture surrounds and optionally with a whirl system or price competitive "Jet-Project" system.



PuraVida bathtub in the surface-mounted version with high rim and as built-in version in the dimensions 200 x 100 cm on the right. It is also available as freestanding version, as back-to-wall bathtub and for corner installation.



(1) PuraVida bathtub as built-in version, 200 x 100 cm. (2) Daro built-in version, shown here as two-seater with 180 x 80 cm. (3) The Happy D.2 built-in bathtub with 2 backrests, 180 x 80 cm. (4) Not without reason, 2nd floor is regarded as an extensive and diverse range. There are also various built-in bathtubs to choose from, shown here in dimensions 170 x 75 cm and combined with a tiled plinth. Like all Duravit built-in bathtubs, it is also available with integrated whirl system.



A new sound module is a melodious option for all Duravit bathtubs: It uses Bluetooth to establish a connection with an MP3 player, mobile phone, etc. More information on p. 195.

Sound via Bluetooth

The built-in bathtubs from the Starck range in the rectangular variant. Straight-lined, minimalist, reduced to the essentials – all to give maximum pleasure to the bather. (top) The one-seater with ergonomically sloping backrest at a 30° angle, here with optional headrest. The Starck two-seater with dimensions 180 x 80 cm offers great comfort and, thanks to the two sloping backrests, requires surprisingly little water.



Step in and feel good. The Darling New corner bathtub, 141 x 141 cm, fits in any corner and also has large surrounds (top).



(1) Exterior: hexagonal. Interior: oval. And the bottom line is: extremely comfortable. Thanks to the optimum use of space – minimal bathtub rim, maximum interior – the 2x3 corner bath offers lots of space: For one person to relax, or for more to splash about and have fun. An ideal bathtub for families or anyone who likes to lie back in a larger bathtub, like all Duravit corner bathtubs, 2x3 is also available with an integrated whirl system. (2) Corner bathtub from the Esplanade range with acrylic panel, 190 x 90 cm, shown here as corner right version.



The reason behind the trapezoidal form of the Paiova bathtub is comfort: it simply offers more space for taking an enjoyable bath. Whether as a one-person bathtub in 170 x 100 cm (1), here with the American Walnut (real wood veneer) bathtub panel, or as a comfortable two-seater for lying side by side (170 x 130 cm or 180 x 140 cm). The step makes it easier to get in and out. It's even more comfortable with the optional headrest. (2) The bathtub with integrated acrylic panel is made from a single piece without any annoying joints.

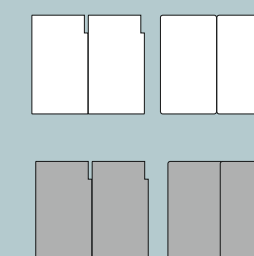

The covers are available in a set of two in white or anthracite and with or without side opening for the shower hose.

Duravit originally developed this design highlight for the Sundeck and Blue Moon bathtubs: with the ingenious covers, the bathtub can be transformed into a comfortable relaxation deck in no time at all. Reason enough to now also offer them separately. With the elements that can be individually combined, it is now possible to transform almost any bathtub into a practical storage area or seat, changing mat or relaxation deck.



The Starck whirltub in action, remote controlled from the rim of the bathtub. A Duravit bathtub can be fitted with five different whirlsystems.



1

Sundeck bathtub 190 x 90cm, with fold-out relaxation deck and bathtub panel in American Walnut (real wood veneer).



2

In the Duravit whirltubs, you not only experience bubbling bathing pleasure but also beneficial after-effects: the air bubbles stimulate the circulation and the water massage stimulates the blood flow. You feel lighter and carefree, muscular pain and tension simply disappear. (1) The Darling New bathtubs offer attractive and effective wellness: a soft, white, atmospheric LED light shimmers below the rim optionally. (2) Paiova whirltub mit bathtub panel in bleached oak (real wood veneer), 170 x 130 cm.

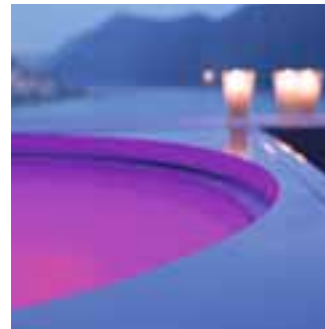

DURAVIT BATHTUBS AND WHIRL TUBS WITH SOUND - THE BENEFITS

- + Entire bathtub becomes a sounding body**
 - A sound system gets the bathtub rocking
 - Music is a truly enjoyable experience
- + Transmission via Bluetooth**
 - Possible with any Bluetooth-compatible device (with A2DP-profile)
 - Volume/track can be controlled from the device
- + Optimum sound**
 - Audio experience both above and under water
 - Musical enjoyment also without water
- + For bath- and whirltubs**
 - Available for all bathtubs and whirltubs
- + Invisible technology**
 - Sound system installed below the tub
- + Easy installation**
 - Only a power connection and mains switch are required
- + Output**
 - 2 x 30 W



Sound via Bluetooth

The Darling New bathtubs offer attractive and effective wellness: a soft, white, atmospheric LED light shimmers below the rim. Like nearly all Duravit bathtubs, the Darling New bathtub is also available with whirl system and colored light in the tub.



The positive effect of color on the human psyche has been medically proven, while light is successfully used for therapy. Colored light can also be used at home, in one's own bathroom, for relaxation and to boost wellbeing. Duravit bathtubs with integrated colored light and LED lights set into the sides of the bathtub create a tranquil, soothing atmosphere. Individual color shades can be selected or they can be set to change subtly at regular intervals. Select from five different programs.



A new sound module is a melodious option for all Duravit bathtubs: It uses Bluetooth to establish a connection with an MP3 player, mobile phone, etc. and also to select the track and volume. Three structure-borne sound converters get your acrylic bathtub rocking and ensure an optimum enjoyment of sound and music, both above and under water. Volume control and track selection via any Bluetooth-compatible music player with A2DP profile. The technology is entirely concealed behind the bathtub so no controls are visible on the bath rim. The module can, of course, be operated with or without water.



(1) **Floor jets:** pre-heated air bubbles surround the entire body to stimulate the circulation and relaxation of the nervous system. (2) **Jets:** a mixture of water and air gently massages the back, thighs and calves. The bubbles stimulate the tissue under the skin, providing relief for muscular pain and tension. (3) **Rotating jets:** rotating water-and-air massage jets gently massage shoulders, lumbar regions and feet to stimulate circulation, increase muscular function and strengthen the organism. (4) **Halogen spotlight:** this creates an even more pleasant bathroom atmosphere. (5) **Colored lighting:** White light, specific colors and a colored light program can all be directly selected.

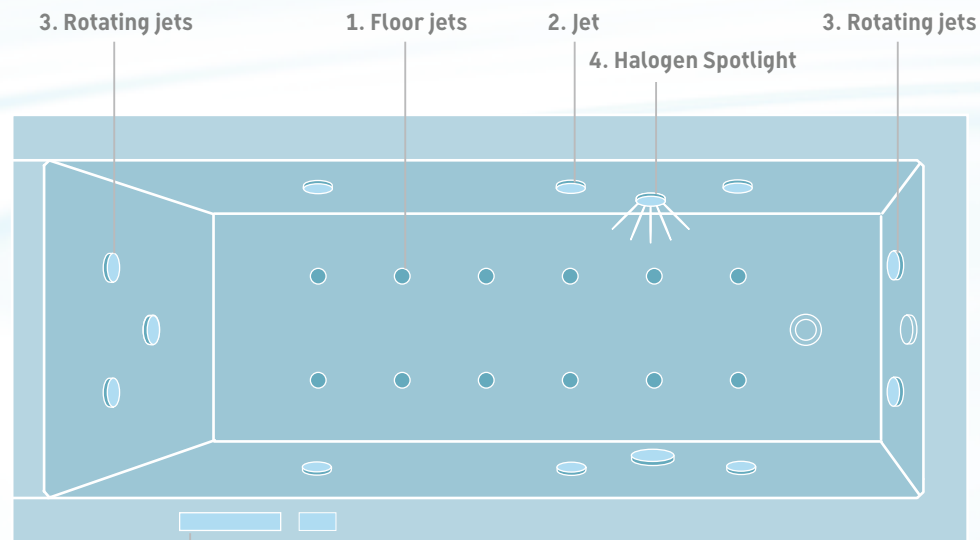

Control unit



Combi L control unit



Combi E control unit



Combi P control unit

Air system. Pre-heated air from 12 air nozzles set into the base of the tub bubbles gently around the entire body. The Air System can be optionally extended to include the additional sound and/or LED colored light module: it uses Bluetooth to establish a connection with an MP3 player, mobile phone, etc. and also to select the track and volume.

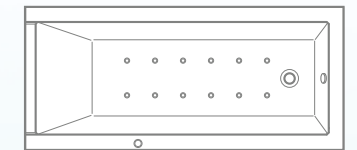

Jet system. Six water-air nozzles arranged in the side wall create a beneficial massage effect. The intensity of the massage jet is regulated via an air controller on the rim of the bathtub. The Jet System can be individually extended to include the additional LED colored light and sound module.

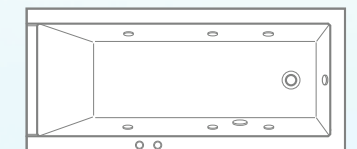

Combi-System P. The positive action of the air-and-jet system is combined in the Combi-System P. In addition, the Combi-System P is fitted with four rotating back massage jets. It is operated via two pneumatic switches and one air controller fitted in the rim of the bathtub. The Combi-System P can be individually extended to include the additional LED colored light and sound module.

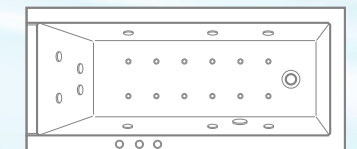

Combi-System E. The electronic control of the Combi-System E offers particular comfort. The air and jet systems, which are included as standard, as well as LED white light and the back and foot massage jets, are all easy and convenient to operate from a compact panel. The Combi-System E can be individually extended to include the additional modules for temperature, LED colored light, sound and UV hygiene management.

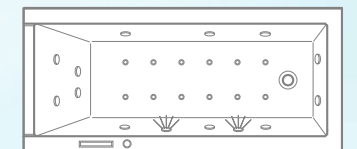

Combi-System L. When touched, the control unit lights up in blue. The air and jet systems, which are included, halogen spotlights (with Blue Moon, two spots) and the back and foot massage jets are all easy and convenient to operate from the compact panel. The Combi-System L can be individually extended to include the additional colored light as LED spotlight (previous page), temperature L and automatic UV hygiene management modules.

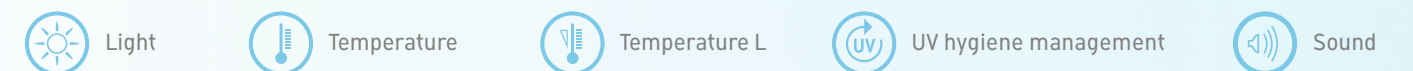
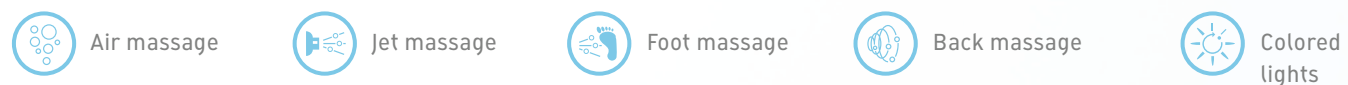
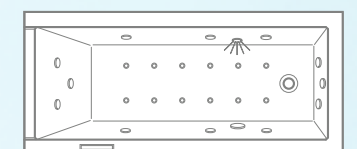

NAHHO.

Not bathing but floating. The Nahho floatation tub enables the bather to enjoy the feeling of weightlessness and complete relaxation.

Design by E00S



With Nahho, Duravit introduces a new form of bathing culture – floating. Nahho is the name of the original canoe, the dugout canoe and floating is that wonderful feeling of stretching out and drifting in water, almost weightlessly.

GOOD REASONS FOR NAHHO

- + Floating effect creates feeling of weightlessness
- + Optional sound module and Durapearl system
- + Height-adjustable neckrest
- + Shower combination thanks to flat entry and combination with OpenSpace

1



The most important prerequisite is a totally relaxed, that is, totally stretched out posture. For this purpose, Nahho features a special headrest. (1) The optional, height-adjustable "bushman" neck rest, designed according to a classic Ethiopian model, further enhances the feeling of relaxation. (2) Visual relaxation: all technical elements such as tap fittings, flood spout or the optional indirect lighting are concealed behind a furniture cover in white matt or graphite matt finish. Nahho is available as built-in (3) and as back-to-wall version (2), optionally also with the Durapearl system (4) and integrated sound module via Bluetooth (5).

► Colored light p. 192 ► Sound systems p. 195 ► Shower partition OpenSpace p. 222



SUNDECK.

An all-in-one bathtub, lounge and wellness source: Sundeck for twice the amount of relaxation – both indoors and outdoors.

Design by E00S

In the bathroom, in the living room or on the terrace... designed by E00S, Sundeck can be set up wherever there is a hot water connection. The practical cover keeps the bathwater at a desirable temperature. But there's more: it folds together to become a comfortable headrest and can be closed to create a relaxing lounge.



(1) The upholstered cover folded together to form a headrest. (2) The hand-sewn white relaxing deck and bolster make for additional comfort. (3) When Sundeck is installed outdoors, a persenning keeps the bathtub and the relaxing deck clean. (4) Sundeck as built-in bathtub, shown here as two-seater with two backrests, 190 x 90 cm. A single-seater, 190 x 90 cm, and an XL two-seater, 210 x 90 cm and 205 x 127 cm, are also available as built-in versions. And for those who would like to experience something more when bathing, the optional Duravit whirlsystem and LED colored lights are available for all versions. (5) Sundeck as a lounger with closed cover.



The freestanding version of Sundeck is available in the sizes 190 x 90 cm, 210 x 90 cm and 210 x 127 cm. The tub panel is available in eight comfortable real wood or wood décor veneers.

GOOD REASONS FOR SUNDECK

- + Perfectly designed Monolith, for relaxing, bathing or enjoying a splash
- + The latest technology is ingeniously integrated in the clear design with no operating elements to disrupt the calming overall impression
- + Clear and calming unit that, thanks to the folding cover, can be enjoyed either opened or closed



The practical remote control adds the finishing touch to the comfort of Duravit pools. Waterproof and easily maintained, it can be used to control all functions – ranging from a gentle tingling to a power massage.



The Sundeck pool has three whirl cycles for perfect wellness: Power, Relax and Emotion, the latter with the new Durapearl nozzles – only water, only air or a mixture of water and air that creates a gently bubbling surface. A control panel is concealed beneath a flap at the side. The pool enjoyment can be controlled via a waterproof remote control. So all you have to do is lie back and relax...



In spite of its size, the Sundeck Pool remains true to Duravit design standards. The bathtub panel is available either in real wood or a wood veneer finish. The Sundeck pool (241 x 131 cm) is available as a corner, wall or freestanding version and without the pool system it can be supplied as a built-in version with variable tub support (205 x 127 cm). When the pool is not being used it can be covered over to create a comfortable flat sundeck with hinged headrest.



BLUE MOON is the ultimate in feel-good bathing — and a high-quality design object. The more water, the more room, the more depth... the better.

Design by Jochen Schmiedem



With its square body and circular tub and an immersion depth of 500 mm, the elegant Blue Moon tub embodies design in its purest form. Immerse yourself completely in water colored with light. Because only the user's back touches the tub, a feeling of pleasant floating weightlessness takes over – and this becomes even more pronounced in the larger version of Blue Moon.



As to style, the bath is based on the modular system. The bath panelling is available in acrylic and in four different wood finishes. The insert is available either in Teak or pure, White Acrylic.



(left) Blue Moon with acrylic panel with Teak inlay and optional Teak bench with stainless steel clothing rail. In addition to the free-standing version there are also corner and back-to-wall versions. (1) For purists: Blue Moon as a bathtub without whirlpoolsystem. (2) Convenient accessory: the comfortable headrest. (3) The whirlpool tub in action, shown here with Teak panel. (4) The optional Teak bench with practical support and clothing rail.



Blue Moon pool, 180x180 cm. Shown here with bathtub panel in American Walnut. Comfort can be individually controlled via the waterproof remote control with functions such as underwater colored light and the Power, Relax and Emotion cycles, which operate either separately or in parallel.





FOR THE OUTSIDE AREA

Practical and tidy – the weatherresistant outdoor persening offers optimum protection. The upholstered cover serves a dual function as a seat or lounger.



GOOD REASONS FOR BLUE MOON

- + Pool feel and bathing fun in two sizes
- + Spacious interior, suitable for one person or two
- + Indoor and outdoor use
- + Sustainable, timeless design
- + Integrated technology that is not visible at first glance



It doesn't always have to be in the bathroom: the freestanding Blue Moon pool is also suitable for installation in conservatories or on the terrace. Either way, it is also available in all variants as bathtub without pool functions. Instead of wood, the Blue Moon pool is also available with acrylic panel. A foot rest, the wooden inlays and separate bench are all practical options. As with the wood inlay, they are also available in Teak (décor). When the cover is no longer required, it can be stored away in the compact, pull-out holder at the side.

► Overview of furniture finishes from p. 246

► Pool systems from p. 216/217

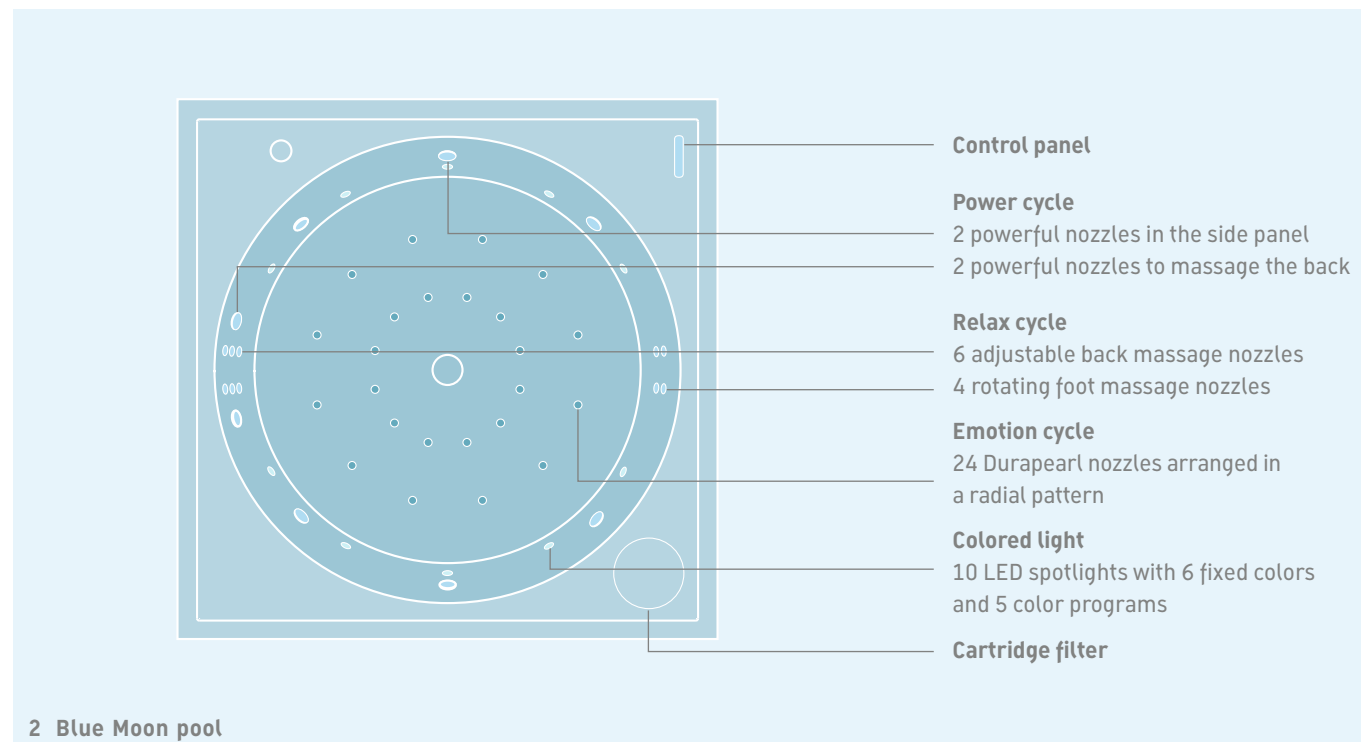
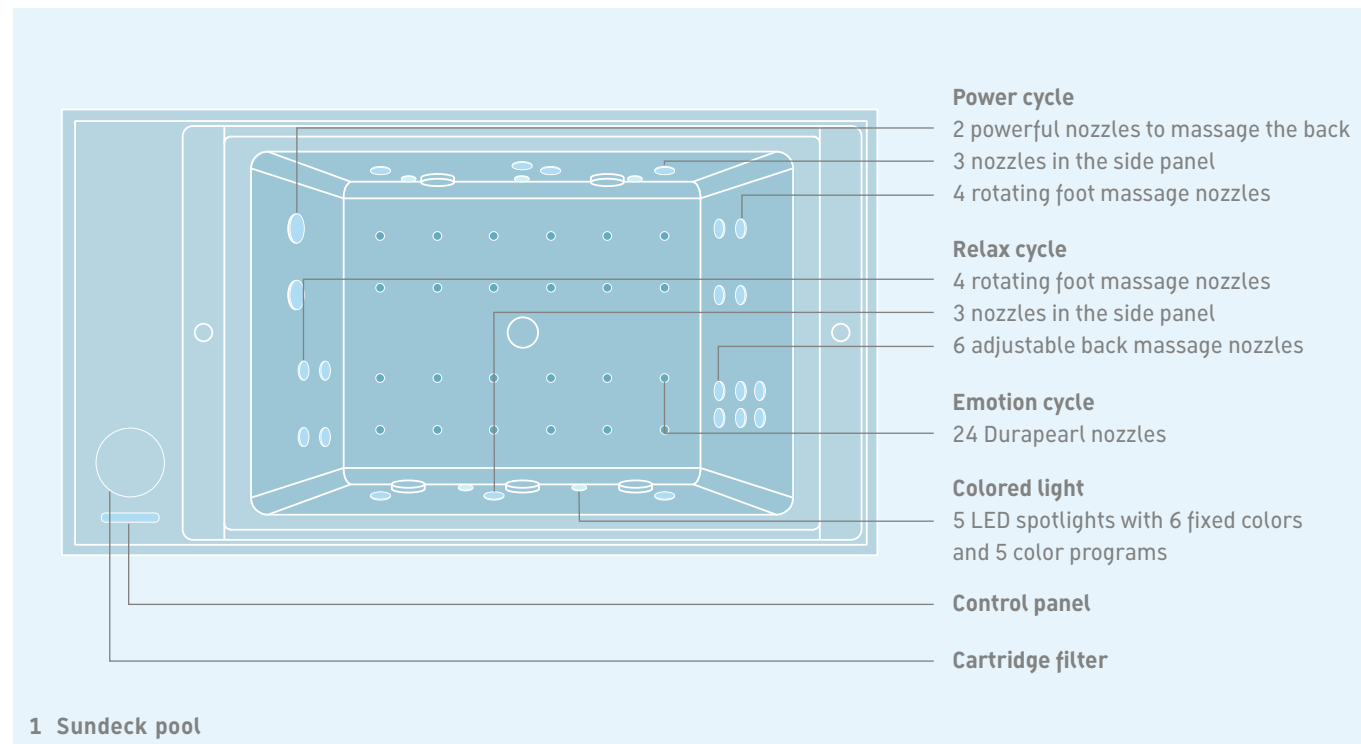

The Duravit (2) Blue Moon and (1) Sundeck pools leave nothing to be desired. Neither in terms of design: the water nozzles are available in white. Nor in terms of function: three whirl cycles ensure bubbling bathing pleasure and can also be combined with colored underwater lights. All programs are operated via a waterproof remote control.

DURAVIT POOL CYCLES

Emotion cycle. Combines 3 functions and offers just the right combination of whirl function to suit every mood. The bubbling, foaming bath with a mixture of water and air is relaxing. The system that just uses air is invigorating and revitalising. The fine water jets create a gentle tingling sensation.

Relax cycle. Depending on the shape of the tub, nozzles arranged in different layouts provide a mild, gentle massage for the muscles on either side of the spine and are combined with the whirling jets from the rotojets for an effective foot massage. This cycle is all about lying back, relaxing and leaving worries and cares behind.

Power cycle. Muscular tension is common in the upper back and shoulder area. The large power jets ensure a powerful massage of the shoulder blades and the shoulder itself. Depending on the shape of the tub, the shoulder massage is combined with massage nozzles in the lumbar area or with a powerful foot and side massage.



POOL COLOR PROGRAMS

Energy. In combination with the "Color Splash" program 1, users can look forward to a lively experience. With this program, the invigorating effect of the pure air bubbles released by the Emotion cycle is particularly beneficial.

Balance. Combined with the "Rainbow" color program 2, the Relax cycle and the bubbling air-and-water mix of the Emotion cycle help to restore your equilibrium.

Awakening. This program is particularly recommended in the mornings because, in combination with the "Sunrise" color program 3, it gradually increases the massage intensity to prepare your body for the day ahead.

Revival. Select this whirl program at the end of a busy day, after work or simply to relax; it is ideal in combination with the "Sunset" color program 4. It starts with an energetic Power cycle massage and ends with the pure water jet of the Emotion cycle.

Fitness. The "Light pulse" color program 5 offers a colorful mix of the different cycles. This program reflects the diversity of the different cycles.





SHOWER TRAYS



SLIMLINE

Now available with reduced rim height. For a safe step, the Starck shower trays are available with the special, transparent, Antislip coating.

Dimensions: 80 x 80 cm – 180 x 90 cm



The models from the Starck range show just how a shower tray can become a design object. Clear and minimalist lines that are aesthetically refreshing and meet all practical requirements. The Starck shower trays are available as built-in models in sizes ranging from 80 x 80 cm to 180 x 90 cm and are suitable for showering together in comfort but also for use with just one shower unit.



ANTISLIP

All Duravit shower trays are also available with the special, transparent, Antislip coating.



Flush fitting shower trays are appreciated by design-conscious bathroom users. In the past, such shower trays had a tendency to pose installation challenges. Duravit has introduced its solution – which allows for installation after floor tiles have been set. DuraPlan can be perfectly combined with the OpenSpace shower partitions (more information from p. 222).



Design by Prof. Frank Huster

Zero height, zero problem. The flush-fitting shower tray DuraPlan. A height-adjustable frame makes it possible to achieve a perfectly-suited space for the tray, while its outlet can be precisely positioned by means of a template. A new and completely watertight drain system prevents the possibility of water damage and if need be, the tray can be removed later to provide access for servicing.

► Shower partition OpenSpace p. 222



OPENSOURCE.

The shower partition that enlarges the bathroom. A shower enclosure takes up a lot of valuable space in the bathroom – but does it really have to?

Design by E00S



The E00S group of designers thinks not and therefore developed the innovative OpenSpace shower enclosure that makes the bathroom bigger. A brilliant chrome frame creates a visual accent that conforms to the contour of the wall. Two large self-locking glass doors are fitted in the frame, in a translucent design or with a mirror on one side. After showering, these doors can simply be „folded“ against the wall. This avoids a rail protruding into the room, the tap fittings and shower hose are concealed and the bathroom appears much larger, particularly with mirrored glass.

GOOD REASONS FOR OPENSACE

- + Creating space with swivel doors
- + Full mirror offers added practicality and creates a greater sense of space
- + Also suitable for barrier-free bathrooms
- + The door is folded against the wall, the tap fittings are concealed



ADJUSTMENT

The integrated U-profile compensates for a wall unevenness of up to 18 mm. This is a great advantage when walls are not completely flat, as is commonly the case in older buildings.



OpenSpace can be perfectly combined with the flush-fitting DuraPlan shower trays (left), but also with other shower trays and bathtubs. This transparent OpenSpace variant in combination with the Nahho floatation bathtub can also be folded against the wall after showering – thereby creating more space for the bather.

► Nahho p. 198



ST.TROP.

The steam shower
by Philippe Starck:
wellness in top form.

Design by Philippe Starck

There are lots of steam showers on the market. But only one designed by Philippe Starck – St.Trop. The steam shower is reduced to the essentials; it is presented as a simple rectangle. The door forms a frame, as with a painting. The inside thus becomes the canvas depicting all kinds of action: showering with a hand-held or overhead shower, steam showers, taking a Kneipp cure or simply relaxing in soft, pleasant light...



GOOD REASONS FOR ST.TROP

- + The wellness-comfort steam shower in the most compact of spaces
- + Perfect design with sculptural elements by Philippe Starck
- + Compact unit, can also be retrofitted

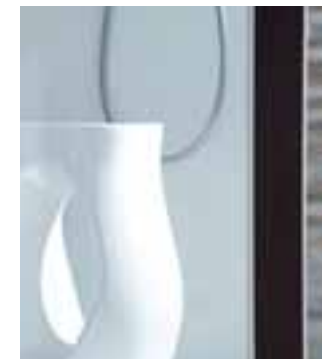

The standard stool also adopts the artistic motif and resembles a modern sculpture. The cabin itself is available in high-gloss white and the aluminium door frame can feature any of 27 different Duravit finishes. The 100x100cm large steam shower is available as back-to-wall and as corner version, left or right.

► Overview of furniture finishes from p. 246



INIPI. The sauna for the bathroom and the living area: thanks to its ingenious layout and lots of transparency, the Inipi sauna module harmonises with the atmosphere.



Design by E00S



The idea of healthy sweating first emerged in Asia as many as 5000 years ago. From there, it spread to Europe and the New World, where the original inhabitants of North America developed their own take on it: "Inipi", a sweat lodge in which hot stones were used to generate the necessary heat. Inspired by this ancient form of sauna, the E00S design team developed an innovative sauna concept for Duravit – compact, transparent and inviting. Inipi's fully glazed front is incredibly chic and particularly effective in the bathroom and living area.



1

MAGICAL STONE

In direct reference to the archaic heat source, the smooth object that feels pleasant to the touch quickly reveals itself as a handy remote control.

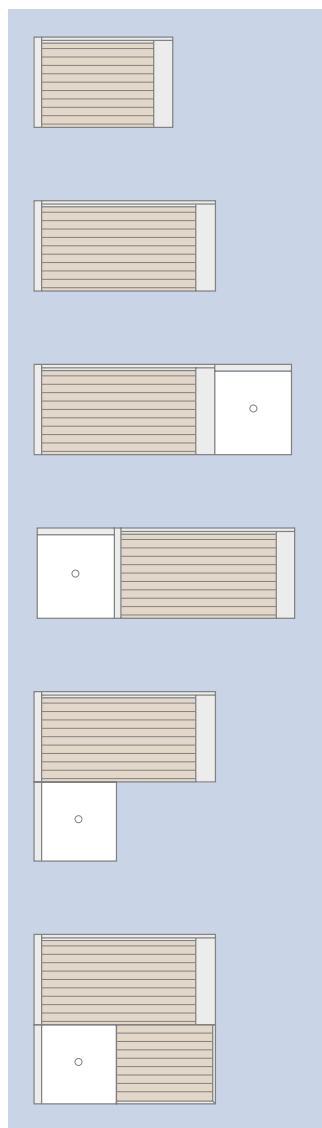

2



3

(1) A remote control unit that looks and feels like a stone – an ode to the traditional Inipi – is available. (2) The sauna's functions can also be controlled using a display fitted behind a flap on the outside of the unit. The heater and water pouring container are integrated into the sauna module but remain concealed behind a panel. The Inipi sauna is available in two different widths, here shown as compact version with 180 cm width.

GOOD REASONS FOR INIPI

- + Luxury sauna experience despite compact dimensions
- + Unique design by E00S that focuses on clarity and conveys a tremendous sense of space
- + Pioneering controls that can be operated remotely
- + Programed sound worlds, lighting scenarios
- and temperature profiles
- + Integration of a wellness shower that can be positioned at the front or side
- + Outstanding technology kept under wraps (e.g. heater / water for pouring over hot stones)



1



2



3



4

Thanks to its ingenious layout, the compact cubicle, here shown in a width of 1800 mm, offers sauna users plenty of space (1). The 235 cm wide version (2-4). The large glass front creates a light, airy atmosphere and further enhances the sense of space. The sitting and lying areas, as well as the floor, wall and ceiling covering are made of natural wood. The feeling of calm, clarity and relaxation is supported by the LED colored light, the "invisible" loudspeaker with radio and the AUX connection together with pre-programed light-sound-climate scenarios.

► Overview furniture finishes from p. 246

The addition of the Inipi Ama shower module as a truly refreshing option





INIPI B. Thanks to Inipi B, the sauna can now be enjoyed in smaller rooms, and yet it still offers sufficient space for relaxing wellness.

Design by E00S

With Inipi, Duravit has taken the idea of a sauna in the bathroom and living area into the realms of respectability. The Inipi sauna concept was inspired by the "sweat lodges" of the North American Lakota Indians, whose rituals included heating stones strewn with herbs in a fire. In Inipi B, the symbol of the stone is found in the control panel, which is used to individually control the sauna temperature, timer for the heater and a digital hour glass. Water is poured over the hot stones at the push of a button inside the sauna.



GOOD REASONS FOR INIPI B

- + Full-fledged sauna in a small amount of space
- + Neat E00S design, both inside and out
- + Intelligent controls, including a button to control the water poured over the hot coals, a timer and ECO mode
- + Energy-saving modes
- + Outstanding temperature profile



NATURALLY COMFORTABLE

Natural sauna comfort with Inipi B: thanks to the sitting and lying elements made of light aspen wood.



Enjoy sweating whilst sitting in comfort. Inipi B comes in two sizes: the larger variant that is approx. 240 x 120 cm offers two people space to lie down in the sauna in comfort. The Inipi B Super Compact variant for one person has a footprint of approx. 120 x 120 cm and fits in just about any corner. Nevertheless, it is large enough for the user to change position during the sauna session, thereby ensuring a comfortable and ergonomic sitting posture, even over longer periods. The backrest with horizontal wooden louvers is individually adjustable and backlit with a soft LED light. The door and side section made of transparent safety glass create a feeling of space.

► Overview of furniture finishes from p. 246

A wealth of ideas

HOLDS AND HOLDS AND HOLDS...

Duravit's patented Durafix attachment system is particularly quick and easy to install and also completely invisible.



TARGET FLY

The target fly positioned in the urinal encourages a more accurate aim.



THE FLOOR-STANDING WASHOUT TOILET

with Cascade flushing technology and Vario outlet was designed for a wide variety of different connection types and dimensions. Whether vertical or horizontal outlet, almost all connections are easy to install.



COMFORT WITH RAISED SEATING POSITION

The Comfort wall-mounted toilet with raised seating position offers real progress in terms of comfort. At 50 mm higher than standard toilets, it can be installed without modifying the inlet and outlet and offers both the tall and the elderly greater comfort when sitting and standing up.

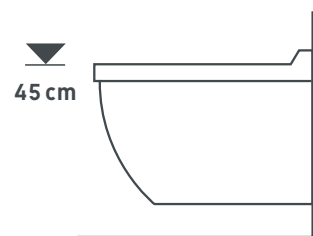

SOFTCLOSE

A gentle tap is all it takes and the toilet seat lowers automatically and closes gently and quietly.



RIMLESS

The open design of the flushing rim enables an innovative water flow. Thanks to modern 4.5-l technology (1 l / sec.), perfect flushing results are guaranteed, even with only a small amount of water.



WHEN SPACE IS AT A PREMIUM

The compact wall-mounted toilets with a minimum projection are the ideal solution when space is at premium.



Compact version



WONDERGLISS

Washbasins, toilets, bidets and urinals treated with WonderGliss stay clean and attractive longer. After the initial firing, WonderGliss is baked into the ceramic by means of a special method.



SEMI-PEDESTAL ATTACHMENT

Thanks to the quick-fitting system, almost all Duravit semi-pedestals can be easily fitted to their matching washbasins and handrinse basins. And, thanks to the simple and sensible attachment technology, the semi-pedestal fits flush against the washbasin and wall.



DUAL FLUSH

With the two-volume technology (3 or 6 liters), a household of four can save more than 40,000 liters of water/year. Press the small button for the small flush volume. A minimum flushing volume washes away liquid waste in a clean and hygienic manner. If you wish to use the full water volume, simply press the large button.

What fantastic furniture!



CRAFTSMANSHIP

Technologically-advanced features are certainly coveted when it comes to new bathroom furniture. What makes Duravit products unique, though, is the fact that all finishing touches on these pieces are performed by hand. The care that Duravit applies to the manufacture of its products is also reflected in the ongoing, meticulous quality controls that are carried out both during and after completion of all manufacturing stages.



A UNIFIED WHOLE

The undercounter washbasins from the Architec, Santosa, Starck 3 and Vero ranges are inserted into the Duravit wooden console from below. An innovative technology allows ceramic and wood to be bonded without jointing – a transition that both looks and feels seamless.



TIP ON

There are no handles to interrupt the clear aesthetics: the cabinets have slightly overlapping doors and the drawers are opened by tip-on technology.



PRECISION WORK

Duravit bathroom furniture is characterized by high precision and careful craftsmanship. A defined miter joint – the right-angled connection between two parts – significantly increases the stability of the furniture. The use of a special adhesive protects against water.

PLEASE HANDLE WITH CARE

Duravit uses an automatic closure system with end damper for its drawers, which ensures that drawers close particularly smoothly and soundlessly. The drawers are braked to the last 10 cm and then close automatically.



EVERYTHING IN ITS PLACE!

Fully extendible and removable without tools, the drawers in Duravit bathroom furniture not only enable the user to make maximum use of their interiors, they also facilitate cleaning.



IT'S LIKE MAGIC

Everyone knows what it feels like when your hands are wet – or even worse, dirty – and you have to switch on the light. This is no longer an issue thanks to the Duravit mirror with integrated lighting. Specially-developed for use in the bathroom, the mirror with integrated lighting features a sensor control that activates the light when it detects hand movement.

SOUNDSYSTEM

The mirror cabinets of the Happy D.2, Delos and X-Large series are optionally available with integrated sound system via Bluetooth. All technical components are concealed behind an elegant panel.



DON'T BE DAZZLED!

For Duravit, optimum light management also includes nonglare lighting. Therefore, special reflectors have been developed that allow the light to shine at the most comfortable angle and that ensure optimum lighting without glare.

AS IF ASLEEP

There's no getting around the fact that some of us have to get out of bed during the night to answer the call of nature. However, one thing we can control is the amount of light: "Night mode," a practical feature integrated into many of Duravit's illuminated mirrors and mirror cabinets, allows users to do just that: it lights the way to the bathroom during the night without being overly bright or imposing.



Sound via Bluetooth

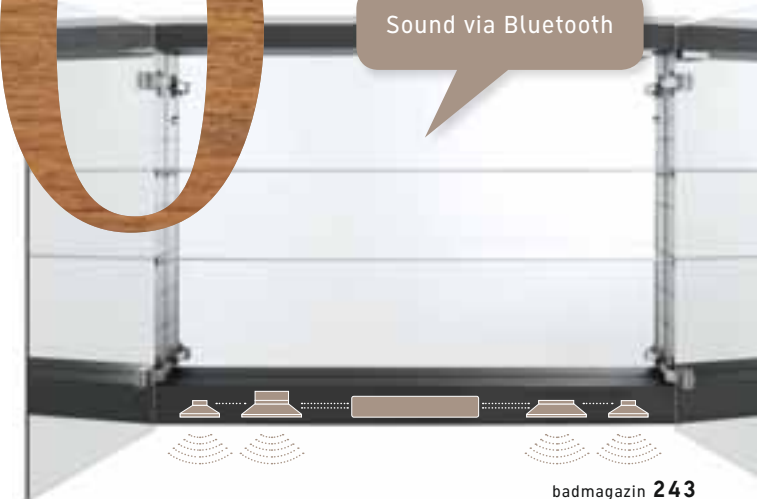

Bathtubs in detail



TWO BATHTUBS WITH GENEROUS DEPTH

It's most enjoyable when you're deeply – and comfortably – submerged in the water. This is why Duravit offers very deep bathtubs. Blue Moon is 500 mm and DuraStyle 490 mm deep. Each guarantees that the entire body is deeply submerged during a bath.



OVERFLOWS ARE ALLOWED

The all-around overflow rim on the Sundeck and Starck bathtubs offers a particularly pleasant and carefree bathing experience. These bathtubs can be filled with water to the very top of the bathtub.



BASE INLET

The tub is filled almost silently from below via the base inlet. The minimalist design is at home in any bathroom architecture, the water inlet can be controlled by any standard tap fitting.

LET THERE BE COLORED LIGHT!

Color has a considerable impact on our sense of wellbeing. As such, there are even more benefits to enjoying colored underwater light in Duravit bathtubs and whirlpools fitted with LED spotlights.



NATURAL BEAUTY

The Duravit universal bathtub panel with wood finish is a particularly attractive idea. Held in place via the innovative EasyClick connection system, it can be easily removed at any time, e.g. for maintenance or repair work. Offered in different wood finishes, the panel is available for installation in corners, niches and back-to-wall for bathtubs from the Darling New, DuraStyle, Starck, Vero and 2nd floor ranges.



MODELLED AFTER NATURE

The flood spout for the 2nd floor range is a good example of how wellness and nature are related – and also an example of how attractive functionality can look. A simple right angle, harmoniously integrated into the bevel, allows the water to flow in a broad, flat surge into the bathtub. And it's no coincidence that it evokes images of a waterfall in untouched nature.



SOUND IN THE BATHTUB

A new sound module is a melodious option for nearly all Duravit bathtubs: it can be connected via Bluetooth to an MP3 player, mobile phone, etc., which can also be used to select the tracks and control the volume

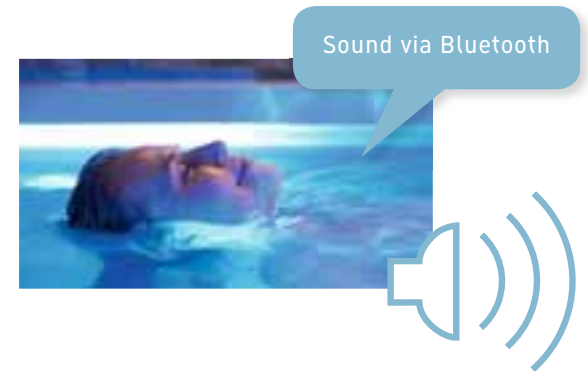

ACRYLIC

The advantage of acrylic is its warm, pore-free and smooth surface. Anyone sitting on the edge of the tub or reclining in the tub while the bathtub fills with water will find the material pleasant to the touch. It is agreeable to the surface sensitivity of the skin, our largest organ: acrylic feels pleasant to the touch and the user immediately feels at ease.



ANTISLIP

All Duravit shower trays are also available with the special, transparent, Antislip coating.



TUB COVERS

With the elements that can be individually combined, it is now possible to transform almost any bathtub into a practical storage area or seat, changing mat or relaxation deck.

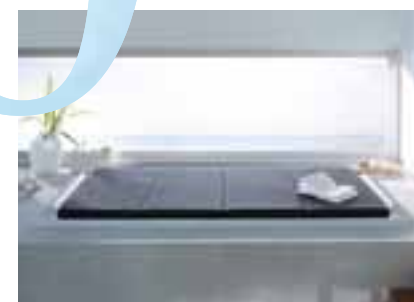

Authentic design

Wood décor consists of a natural-looking décor layer soaked in melamine resin and several support layers. These are compressed to form a robust surface that is light and UV-resistant, as well as easy to clean. The ABS profile is attached to protect the edges; it is scratch and impact-resistant. The wood décor is machine-made to guarantee that it will retain its look for years to come.

	Outdoor (Décor)		Indoor (Décor)							Indoor (Décor)									
Color	01 - Cherry Tree (Outdoor)	02 - Wengé (Outdoor)	14 - Terra	15 - Spring	18 - White Matt	22 - White High Gloss	29 - Azur	31 - Pine Silver	43 - Basalt Matt	49 - Graphite Matt	50 - Garnet Red Matt	51 - Pine Terra	52 - European Oak	53 - Chestnut Dark	67 - Rosewood	70 - Aluminium	75 - Linen	79 - Natural Walnut	
Color number	01	02	14	15	18	22	29	31	43	49	50	51	52	53	67	70	75	79	
2nd floor	[Grid]																		2nd floor
Darling New	[Grid]																		Darling New
DuraStyle	[Grid]																		DuraStyle
Happy D.2	[Grid]																		Happy D.2
Ketho	[Grid]																		Ketho
PuraVida	[Grid]																		PuraVida
X-Large	[Grid]																		X-Large
2nd floor	[Grid]																		2nd floor
Blue Moon	[Grid]																		Blue Moon
Darling New	[Grid]																		Darling New
DuraStyle	[Grid]																		DuraStyle
Inipi	[Grid]																		Inipi
Inipi B	[Grid]																		Inipi B
Nahho	[Grid]																		Nahho
Paiova	[Grid]																		Paiova
PuraVida	[Grid]																		PuraVida
Starck	[Grid]																		Starck
St.Trop	[Grid]																		St.Trop
Sundeck	[Grid]																		Sundeck
Vero	[Grid]																		Vero

 Bathroom furniture ranges
 Panel for bathtubs, surfaces for saunas and steam showers
 * Recessed grip and console
 ** Shadow gap
 K Flap

The natural feel-good factor

A veneer comprises thin slices of wood that are produced either by sawing, cutting or peeling the trunk of a tree. They are then adhered to a substrate. As with every tree, each real wood veneer is a unique piece of nature. Every piece of veneered furniture is thus unique and the differences in structure and color indicate the distinctiveness of the materials used. With their great aesthetic appeal, real wood veneers give our bathroom furniture a high-quality look and are also warm and pleasant to the touch. To ensure that this remains so for a long time to come, the surface of the wood is also protected with a layer of melamine resin. Painted surfaces have several layers of paint to guarantee a particularly high-quality look and finish.



	05 - Oak	12 - Brushed Oak	13 - American Walnut	24 - Macassar	26 - American Cherry Tree	59 - Ebony	62 - Anthracite Oak	65 - Bleached Oak	69 - Brushed Walnut	72 - Brushed Dark Oak	82 - White Acryl	40 - Black High Gloss	56 - Silk	85 - White High Gloss	86 - Cappuccino High Gloss	88 - Red High Gloss
2nd floor																
Delos																
Esplanade																
Fogo																
Happy D.2																
PuraVida						*						*				*
Starck																
X-Large																

	05 - Oak	12 - Brushed Oak	13 - American Walnut	24 - Macassar	26 - American Cherry Tree	59 - Ebony	62 - Anthracite Oak	65 - Bleached Oak	69 - Brushed Walnut	72 - Brushed Dark Oak	82 - White Acryl	40 - Black High Gloss	56 - Silk	85 - White High Gloss	86 - Cappuccino High Gloss	88 - Red High Gloss
2nd floor																
Blue Moon																
Darling New																
DuraStyle																
Esplanade																
Inipi																
Inipi B																
Nahho																
Paiova																
PuraVida						**						**		**		**
Starck																
St.Trop																
Sundeck																
Vero																

■ Bathroom furniture ranges ■ Panel for bathtubs, surfaces for saunas and steam showers

* Recessed grip and console ** Shadow gap



LIFE IS AN
ADVENTURE.
OURS STARTED
IN 1817.

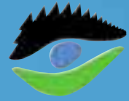

We are a sponsor of the Black Forest
Nature Park Central/North.



TRADITION AND THE REGION BEHIND THE DURAVIT BRAND.

The tradition of the Duravit brand. Even a company that has set great precedents with its centuries-old tradition once “started small.”

It all began in Hornberg, Germany in 1817 when Georg Friedrich Horn built an earthenware factory initially focused solely on the manufacture of crockery. In 1956, production evolved from earthenware to porcelain, extending the product range to include sanitary ceramics. This provided a platform for future success and also introduced the sanitary world to a new name: Duravit. Today, Duravit AG operates at an international level and boasts 10 production plants with a workforce of more than 5,000 employees worldwide.

The region behind the Duravit brand. One source of Duravit’s tremendous strength, which it continues to cultivate, is its deep connection to the Black Forest. This is why Duravit is, for example, a partner and sponsor of the Black Forest natural park, a large nature reserve that is also Germany’s largest natural park. Additionally, Duravit does everything possible to protect natural elements like water, air and soil – a process that starts with resource-saving manufacturing methods, which employ technologies such as water treatment and heat recovery. The logical continuation of this is manifested in the products themselves, which are water-saving.

“Hand made” quality assurance. Even though we’re living in an age of high-tech and automation, when it comes to products with such a high claim to design and function, quality is often still down to human skill. Duravit continues to maintain a great deal of craftsmanship wherever it’s important to ensure this high standard. This applies both to ceramic manufacture and to all other production areas at Duravit.



Even with new products, Duravit takes into impact on the environment and ensures that, whatever it manufactures, it uses natural resources responsibly.

And these efforts have certainly been recognized: Duravit AG has officially been certified for its commitment to the environment in accordance with ISO 14001.



DESIGN AND SUSTAINABILITY. THE DURAVIT BRAND.

Matteo Thun, Philippe Starck, E00S
Lord Norman Foster, Phoenix Design, Prof. Frank Huster,
Christian Werner, Sergei Tchoban, sieger design.



The Duravit design brand. How do we actually recognize good design? After all, individual tastes can be so very different. Nevertheless, certain attributes serve as benchmarks and qualifiers for innovation.

First, Duravit has been the proud recipient of numerous international design awards. These awards celebrate bold design, which has become Duravit's hallmark over the years. Second, there are the designers themselves. Each designer is a specialist in his field – a prominent global innovator with an inherent sense for good design. Good design, as Duravit and its designers see it, is never at the expense of practicality – neither is interested in “design for design's sake.”

And third? That's you, the bathroom user, and your own set of needs and requirements. Thanks to an ongoing dialogue with its trade partners and sanitaryware dealers, Duravit is best able to address these needs and requirements in the brand's designs. Simply put, Duravit recognizes good bathroom design by the fact that it seems specially-created to suit all individual tastes.

Duravit and sustainability. Today, everyone's talking about environmental responsibility – a practice that Duravit has championed for years in its selection of materials, technological applications and production methods. Sustainability is the very reason Duravit continues to work with sanitary ceramic, a material that dates back to 8,000 BC. Today, the manufacture of Duravit sanitaryware ceramic continues to employ the same basic materials – clay, kaolin, feldspar and quartz – a set of natural, regenerative substances. This fusion of Duravit's environmentally-friendly production technologies with the company's meticulous quality control results in products that are highly functional and long-lasting.

At Duravit, sustainable materials, modern expertise and the foresight to recognize what will be important tomorrow comprise the essential ingredients for beautiful – and responsible – living bathrooms.

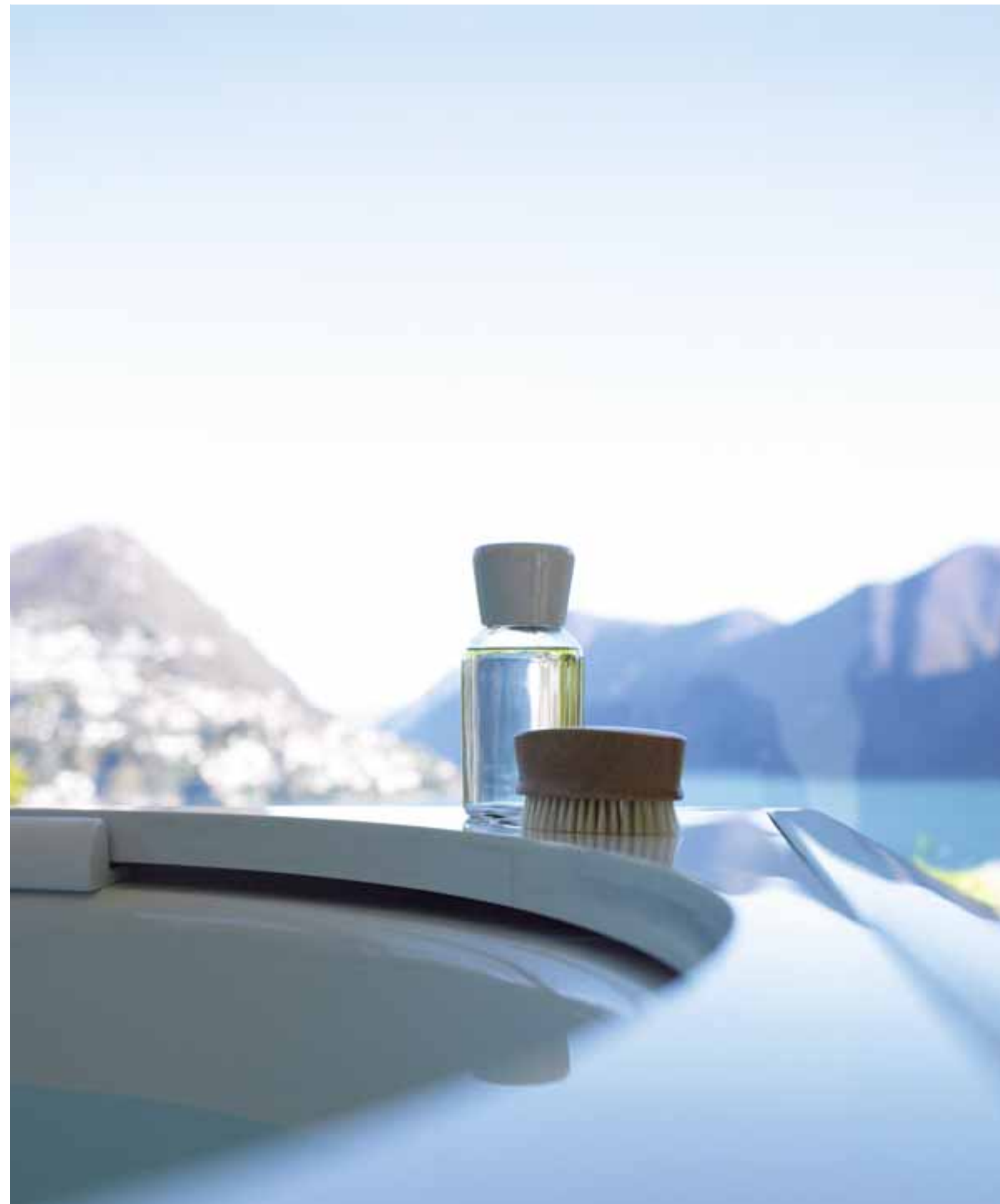



WELCOME TO DURAVIT.
IN HORNBERG,
IN MEISSEN - IN
FACT, ANYWHERE
IN THE WORLD.



Duravit Showrooms: Hornberg and Meissen (Germany), New York (USA), Paris (France), Cairo (Egypt), Bizerte (Tunisia) and Shanghai (China). More Information? www.duravit.com/showrooms

The international breadth of the Duravit brand. Perhaps at a time when the world is getting smaller by the day, it may not be so unique to have production plants and showrooms around the globe. Nevertheless, we are more than a little proud to be able to welcome you to our showrooms in Manhattan, Paris or Shanghai.

On the other hand, you don't actually have to be in a metropolis in order to step foot inside the Duravit world. The Duravit Design Center, located in Hornberg – at the heart of Germany's Black Forest – offers a very authentic Duravit experience. Designed by Philippe Starck, the Duravit Design Center showcases bathrooms, building history and design options over an area of more than 1.500 m².

Another option is to visit Duravit's 600 m² showroom in Meissen, where you can find out everything you want to know about our bathroom and wellness products. Both showrooms have one thing in common: they offer you an opportunity to create your very own Duravit dream bathroom. And – you can even try out the products for yourself! Why not make an appointment?





However, durability and high product quality can only be achieved when certain standards are met with regard to the responsible choice of material, careful workmanship and attention to detail. All with one aim: we want you to enjoy our products for a very long time.

IT IS NOT WITHOUT REASON THAT THE NAME DURAVIT IS DERIVED FROM THE WORD 'DURABILITY'.

Sanitary ceramic – extremely high-performance and resilient. The basic ceramic mass consists of the natural raw materials clay, kaolin, quartz and feldspar. Quartz, chalk, feldspar and the mineral stone dolomite are mixed to make the glaze. The extreme high temperature resistance allows a firing temperature of approx. 1280°C. This results in a very high level of hardness, which is particularly advantageous in public sanitary facilities. The hygienically smooth surface glaze is wear and scratch-resistant, easy-care and thus ideal for use in the health sector. Sanitary ceramic is kind to the skin, heat resistant and lightfast. The Wonder-Gliss surface finish keeps washbasins, toilets and bidets attractive and clean for a long time and is made exclusively from raw materials that are not harmful to health.

Acrylic – a material with attractive properties. The advantage of acrylic is its warm, pore-free and smooth surface. It is pleasant to the touch and the user immediately feels at ease. With its white shimmering gleam, the material harmonizes with all of the other ceramic objects in the bathroom and ensures continuity of design. The bathtubs can be elegantly combined with furniture panel thus forming a link with the bathroom furniture. The user can rest assured knowing that the acrylic bathtub will retain its color throughout its lifetime. The material is colored throughout, UV-stable and colorfast. A bathtub made from sanitary ceramic is not only easy to install, it is also resistant to almost all conventional cleaning agents.

Wood – brings the bathroom together. Wood is comfortable, elegant and boasts particularly easy-care properties. This is why warm wood tones are increasingly making their way into the bathroom. With vanity units and wooden panel, the washbasin and bathtub themselves become pieces of furniture. They are complemented by wall cabinets, wall-mounted shelves and mobile storage units. This creates an integral concept that includes and brings together all conceivable aspects of the bathroom. To underscore the welcoming aspect in the bathroom, Duravit invests in a range of different real-wood veneers, as well as a variety of painted and décor surfaces. Bathroom furniture is manufactured specifically for use in this application area and is resistant to splashwater and increased humidity. The edges are PVC-free and water resistant. The surfaces are sealed with extreme care to make them water-repellent.