



Globally Proven
Construction Solutions

Proven Installation Systems for Tile and Stone Applications

Underlayments Crack Suppression Shower System Waterproofing Sound Control
Floor Warming Adhesives Mortars Grouts Caulk



Al Hamra Tower, Kuwait City, Kuwait



North Carolina Museum of Natural Sciences, Raleigh, NC



Harvard Law School, Cambridge, MA



Marina Bay Sands Singapore® Infinity Edge Pool at the Sands® SkyPark, Singapore, Southeast Asia

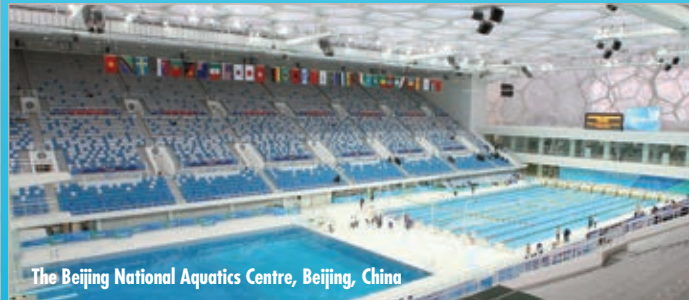

The Beijing National Aquatics Centre, Beijing, China

Worldwide Availability ■ Industry Standard ■ Code Approved
25 Year System Warranty ■ On Site Technical Assistance



Snap for more information.

Interior Exterior Commercial Residential Industrial





Complete System Warranties.....	4
Certifications.....	5
Wet Areas and Continuous Submersion System	6 – 7
Vapor Reduction System	8 – 9
Self-Leveling / Underlayment System.....	10 – 11
HYDRO BAN® Shower Installation System	12 – 13
Commercial and Industrial Flooring System.....	14 – 15
Sound Control System	16 – 17
Uncoupling System	18 – 19
Vertical Installation System	20 – 21
Plaza and Deck System	22 – 23
Masonry Veneer Installation System (MVIS™)	24 – 25
Grout Solutions.....	26 – 27

COMPLETE SYSTEM WARRANTIES

LATICRETE offers a comprehensive 100% labor and materials warranty for tile and stone installations, underwritten by a AAA rated Global Insurance Company.

- The most comprehensive assortment of tile and stone installation materials available for virtually any tile or stone application around the world
- LATICRETE® warranties cover any suitable tile or stone manufacturer's product, allowing you to select the appropriate product and finish you desire for your project with confidence
- Customizable warranties are available to suit your specific project requirements

CERTIFICATIONS

LATICRETE materials are certified by independent laboratories throughout the world to meet or exceed applicable industry standards/norms, including: DIN, EN, ANSI, AS, ISO, UEATC, JIS, ASTM, ABSAC, and UPC® IAPMO and the ICC.

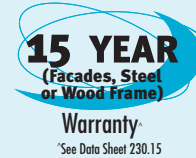

PRODUCT SELECTION GUIDE

PRODUCT TYPE/DESCRIPTION	PRODUCT NAME	USE	SUBSTRATE TYPE	APPLICABLE STANDARDS
UNCOUPLING				
Uncoupling Mat	STRATA_MAT™	I	1, 4, 6, 7	N/A
SURFACE PREPARATION				
Self-Leveling/Underlayments	NXT™	I	1, 2, 3†, 4*, 6††	N/A
Vapor Reduction Membrane	LATAPOXY® 312 Vapor Reduction Membrane	I	1	N/A
Leveling Floors and Walls (Thick Bed)	3701 Mortar Admix	I, E	1, 2, 3†, 4, 6	N/A
Crack Suppression, Anti-Fracture	125 Sound & Crack Adhesive	I	1, 3†, 4*, 6	ANSI A118.12
	HYDRO BAN®	I, E	1, 2, 3†, 4*, 5, 6	ANSI A118.12
For Installing Ceramic Tile or Stone to Exterior Plazas and Decks	Plaza & Deck System	E	1, 6	N/A
Sound Control Underlayment	125 Sound & Crack Adhesive	I	1, 3†, 4*, 6	ANSI A118.13
	170 Sound & Crack Isolation Mat	I	1, 3†, 4*, 6	ANSI A118.13
WATERPROOFING				
Waterproofing — Liquid Applied Commercial, Extra Heavy Duty	HYDRO BAN	I, E	1, 2, 3†, 4*, 5, 6	ANSI A118.10 & ANSI A118.12
	9235 Waterproofing Membrane	I, E	1, 2, 3†, 4*, 5, 6	ANSI A118.10 & ANSI A118.12
EPOXY ADHESIVE				
100% Solids Epoxy Adhesive (Maximum Strength & Chemical Resistance)	LATAPOXY 310 Stone Adhesive	I	1, 2, 3†, 6, 8 ^U	ANSI A118.3, ISO 13007-1
	LATAPOXY 300 Stone Adhesive	E**	1~, 2 ^Δ	ANSI A118.3, ISO 13007-1
	LATAPOXY 310 Adhesive	I, E**	1, 2, 3†, 4, 5, 6, 7, 8 ^U	ANSI A118.3, ISO 13007-1
MULTIPURPOSE CEMENT MORTAR				
Premium Polymer Fortified Thin-Set Mortar	254 Platinum	I, E	1, 2, 3†, 4, 5, 6, 7	ANSI A118.4, ANSI A118.11, ISO 13007-1
	4-XLT	I, E	1, 2, 3†, 4, 5, 6††	ANSI A118.4 & ANSI A118.11
	MULTIMAX™ 255	I, E	1, 2, 3†, 4, 5, 6††	ANSI A118.4, ANSI A118.11 & ISO 13007-1
GROUTS AND GROUT ADDITIVES				
Cross Linking Technology Epoxy Grout	SPECTRALOCK® PRO Premium Grout*	I, E	N/A	ANSI A118.3
Premium Cement Based Grout	PERMACOLOR® Grout	I, E	N/A	ANSI A118.7, ISO 13007-3
100% Solids Epoxy Grout — Industrial	SPECTRALOCK 2000 IG	I, E	N/A	ANSI A118.3 & ANSI A118.5

USE

I = Interior E = Exterior

SUBSTRATES

- 1 = Concrete
- 2 = Masonry
- 3 = Cementitious Backer Board/Plaster
- 4 = Existing Ceramic, Stone, Cement Terrazzo

5 = Gypsum Board/Plaster (Interior Only)

6 = Exterior Glue Plywood (Interior Only)

7 = Vinyl, Plastics, Laminates (Interior Only)

8 = Steel

N/A = Not Applicable

† Interior use only

* Skim coat with 254 Platinum.

** Exterior applications with LATAPOXY® 310 Stone Adhesive or LATAPOXY 300 Adhesive must be approved by LATICRETE Technical Service prior to installation.

†† Consult cement backer board manufacturer for specific installation recommendations and to verify acceptability for exterior use.

‡ Interior use only; 2 layers each 5/8" (15 mm) minimum and mechanically fastened 3.4# diamond metal lath.

Δ United States Patent No.: 6881768 (and other Patents).

~ Concrete must be 152mm thick, 28 days old, have a compressive strength of 3,500 psi (24 MPa), and be free of curing compounds, sealers, form release agents, or other potential bond breakers.

Δ Double width concrete masonry unit wall construction.

⊜ Steel surface must be cleaned to remove oil, dust oxidation and other bond inhibiting materials.



With over 50 years of worldwide experience, LATICRETE is the recognized leader in product quality and installation expertise. Our highly trained and experienced technical support personnel stand ready to assist you with project specifications, details, LEED compliance information, and to address any installation questions for your project.



UL GREENGUARD Gold Certification Breathe Easier – And Safer

LATICRETE was the first manufacturer of tile and stone installation systems to incorporate antimicrobial performance in its products and offer UL GREENGUARD Gold certification. LATICRETE offers a complete line of certified low VOC installation materials, all of which have been independently tested and certified by UL Environmental. Many companies might say their products are low VOC, only one independently certifies it – LATICRETE.

- LATICRETE provides third party UL GREENGUARD Gold certification, required to meet stringent indoor air quality standards
- UL GREENGUARD Gold certified for use in all school projects
- Helps contribute toward LEED certification
- Product certifications readily available

LATICRETE Architectural Guidebook Project Specification Assistance

- Complete specifications generated easily and quickly online
- Details for project specification and design

To use this tool, simply visit www.laticrete.com/ag today.

LATICRETE offers BIM-Compliant, Revit format details that are used in conjunction with our library of standard CAD details. You can now generate specifications even faster, and with greater clarity and ease. Our integrated 2D and 3D model-based details allow you to quickly and easily reference, manipulate, and visualize detail components electronically. BIM compliant details are available at www.laticrete.com/green or by contacting LATICRETE Technical Services at 1.800.243.4788 x235.

Training and Education

- AIA HSW Continuing Education Seminars: Choose from numerous 1 hour AIA CEU presentations available in a Lunch & Learn format right in your office.
- Profit Through Knowledge Seminars: Product and Installation Technology training seminars hosted periodically at the LATICRETE Training Centers around the world.
- On-Site Contractor Training Sessions: Product specific training available right on site hosted by local LATICRETE representatives – available when and where you want it.

LATICRETE LEED Project Certification Assistant

Specifying tile and stone installation materials for projects seeking LEED certification is now faster and easier than ever before. The LATICRETE LEED Project Certification Assistant is an online tool which automatically generates all of the information required for LATICRETE products on a specific LEED project, eliminating manual collection of data.

- Quickly produces an adobe acrobat file for each LATICRETE product selected stating its VOC content, recycled content, manufacturing location, raw material sources, UL GREENGUARD Gold Certification (if available), technical data sheets, and a map showing the location of your project with a 500-mile radius circle depicting its relation to LATICRETE manufacturing facilities
- Eliminates the challenge of obtaining and quantifying the necessary data for LEED-compliant installation materials
- Detailed, accurate information in just a few moments

To use this tool, simply visit www.laticrete.com/green today.





WET AREA AND CONTINUOUS SUBMERSION SYSTEM

The single source system approach for continuous submerged and wet area applications.



LATICRETE offers the latest technology in construction materials which deliver superior performance in wet area and continuous submersion applications. Designed to resist chemicals, shock treatment and pH imbalance of water, the LATICRETE system provides flexibility and high strength for these demanding, high performance applications.



SYSTEM COMPONENTS:

HYDRO BAN®

- Bonds directly to metal and a variety of plastic plumbing fixtures
- Anti-fracture protection of up to 1/8" (3 mm) over shrinkage and other non-structural cracks
- Extra Heavy Service rating per ASTM C627 performance levels
- Meets ANSI A118.10 and ANSI A118.12 standards
- IAPMO and ICE approved

254 Platinum

- Suitable for interior and exterior applications.
- Exceptional bond strength and easy workability
- Microban® antimicrobial protection
- Exceeds ANSI A118.4, ANSI A118.11 and ANSI A118.15
- Meets EN 12004/C2TES1 and meets ISO 13007-1/C2TES1P1

SPECTRALOCK® PRO Premium Grout[^]

- Maximum performance epoxy grout
- Available in 40 colors
- Stainproof^{^^} and chemical resistant
- Easily installs on floors and walls; never needs sealing
- Use in interior and fully submerged applications
- Exceeds ANSI A118.3

PERMACOLOR® Grout[†]

- High Performance cement based grout
- Inhibits the growth of stain-causing mold and mildew with Microban®
- Exceeds ANSI A118.7
- Meets EN 12888/CG2WA and meets ISO 13007-3/CG2WA

LATASIL™

- 100% silicone sealant
- Available in 25 colors and clear
- Use in fully submerged or wet areas when used with LATASIL™ 9118 Primer
- Meets ASTM C794 and C920

SYSTEM APPLICATIONS:

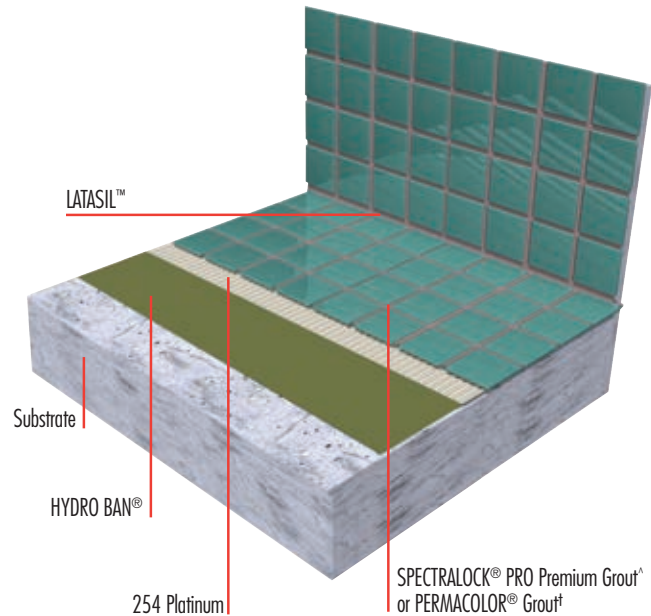

For the thin-set method of installation, 254 Platinum is recommended, designed for interior and exterior applications, submerged installations, and provides a superior bond to concrete and masonry surfaces.

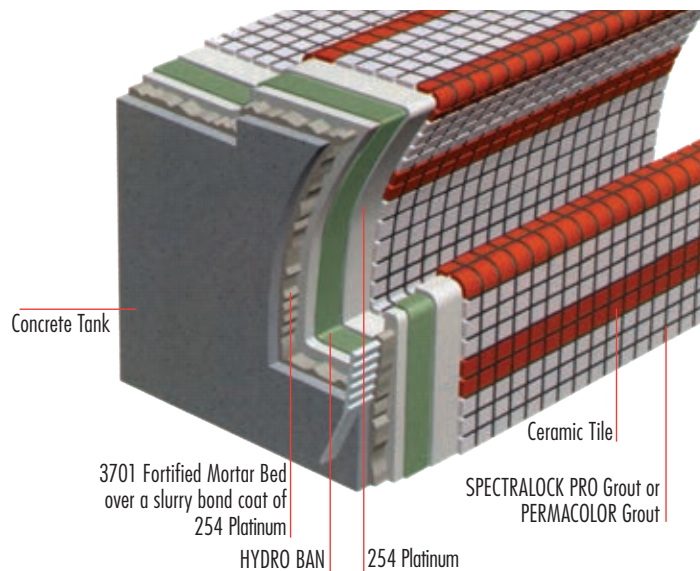

For the thick bed method of installation, 3701 Fortified Mortar Bed is exceptionally strong and resistant to weather, frost, salt, thermal, and physical shock.



^{^^}StainProof (residential installation only) to common household cleaners, liquids and other goods. Clean all spills immediately.

[^]United States Patent No.: 6,881,768 (and other Patents).
[†]United States Patent No.: 6,784,229 B2 (and other Patents).



VAPOR REDUCTION SYSTEM

Surpasses industry recommendations for moisture vapor emissions.



The NXT™ Vapor Reduction System can be used for the installation of ceramic tile, stone, vinyl, or other flooring. NXT vapor reduction coating is a high performance, roller applied epoxy membrane specifically designed to reduce the vapor transmission from concrete slabs through to a finished floor surface.



SYSTEM COMPONENTS:

NXT™ Vapor Reduction Coating

- Ideal for slab on grade construction
- Allows the installation of vinyl, wood, epoxy, tile, stone and other floor coverings
- Reduces moisture vapor emission rate from 12 lbs/1000 ft² in 24 hours to below 3 lbs/1000 ft² in 24 hours

NXT Level Plus

- High quality cement based underlayment
- Install from 1/8" – 1 1/4" (3–32mm) in a single lift
- Apply directly over concrete with RH of 95% or less per ASTM F2170

3701 Fortified Mortar Bed

- Polymer fortified – no need for latex additives
- Economical – saves time and money
- High strength formula
- Exceeds ASTM C270 requirements

254 Platinum

- Suitable for interior and exterior applications.
- Exceptional bond strength and easy workability
- Microban® antimicrobial protection
- Exceeds ANSI A118.4, ANSI A118.11 and ANSI A118.15
- Meets EN 12004/C2TES1 and meets ISO 13007-1/C2TES1P1

SPECTRALOCK® PRO Premium Grout[^]

- Maximum performance epoxy grout
- Available in 40 colors
- Stainproof^{^^} and chemical resistant
- Easily installs on floors and walls; never needs sealing
- Use in interior and fully submerged applications
- Exceeds ANSI A118.3

PERMACOLOR® Grout[†]

- High Performance cement based grout
- Inhibits the growth of stain-causing mold and mildew with Microban®
- Exceeds ANSI A118.7
- Meets EN 12888/CG2WA and meets ISO 13007-3/CG2WA

LATASIL™

- 100% silicone sealant
- Available in 25 colors and clear
- Use in fully submerged or wet areas when used with LATASIL™ 9118 Primer
- Meets ASTM C794 and C920

SYSTEM APPLICATIONS:

Tile and Stone System

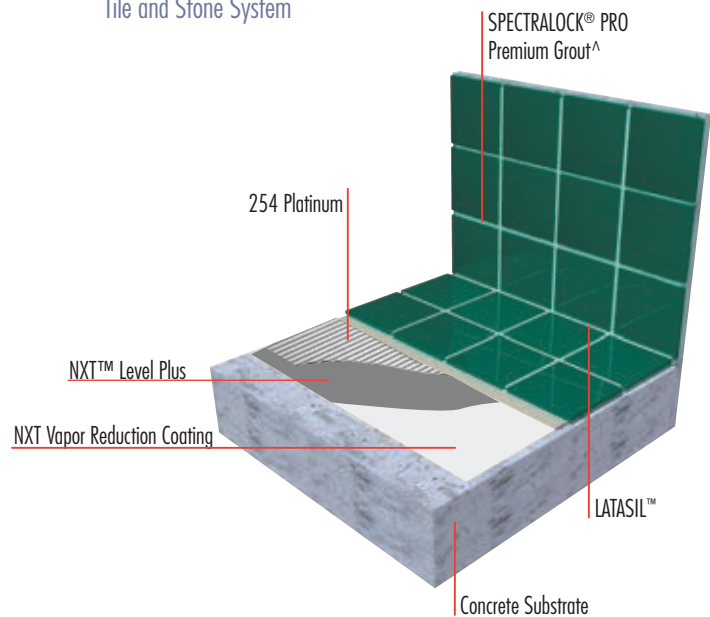

Vinyl Adhesive System

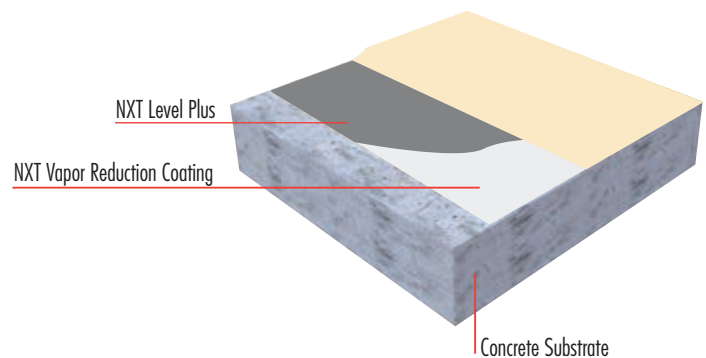

The NeXT evolution
of substrate preparation
from LATICRETE.



Continuing in the tradition of leveraging our global strength, LATICRETE has again delivered a family of products that will revolutionize the flooring industry. NXT™ substrate preparation products have been formulated using state-of-the-art technology which provide world class performance for a variety of applications including self-leveling underlayments, patching and skim coating products.



SYSTEM COMPONENTS:

NXT™ Primer

- Water-based primer designed for use with NXT underlayments
- Deep penetrating formula maximizes bond strength

NXT Level Plus

- High quality cement based underlayment
- Install from 1/8" – 1 1/4" (3–32mm) in a single lift
- Apply directly over concrete with RH of 95% or less per ASTM F2170

HYDRO BAN®

- Bonds directly to metal and a variety of plastic plumbing fixtures
- Anti-fracture protection of up to 1/8" (3 mm) over shrinkage and other non-structural cracks
- Extra Heavy Service rating per ASTM C627 performance levels
- Meets ANSI A118.10 and ANSI A118.12 standards
- IAPMO and ICE approved

254 Platinum

- Suitable for interior and exterior applications
- Exceptional bond strength and easy workability
- Microban® antimicrobial protection
- Exceeds ANSI A118.4, ANSI A118.11 and ANSI A118.15
- Meets EN 12004/C2TES1 and meets ISO 13007-1/C2TES1P1

SPECTRALOCK® PRO Premium Grout[^]

- Maximum performance epoxy grout
- Available in 40 colors
- Stainproof^{^^} and chemical resistant
- Easily installs on floors and walls; never needs sealing
- Use in interior and fully submerged applications
- Exceeds ANSI A118.3

PERMACOLOR® Grout[†]

- High Performance cement based grout
- Inhibits the growth of stain-causing mold and mildew with Microban®
- Exceeds ANSI A118.7
- Meets EN 12888/CG2WA and meets ISO 13007-3/CG2WA

SYSTEM APPLICATIONS:

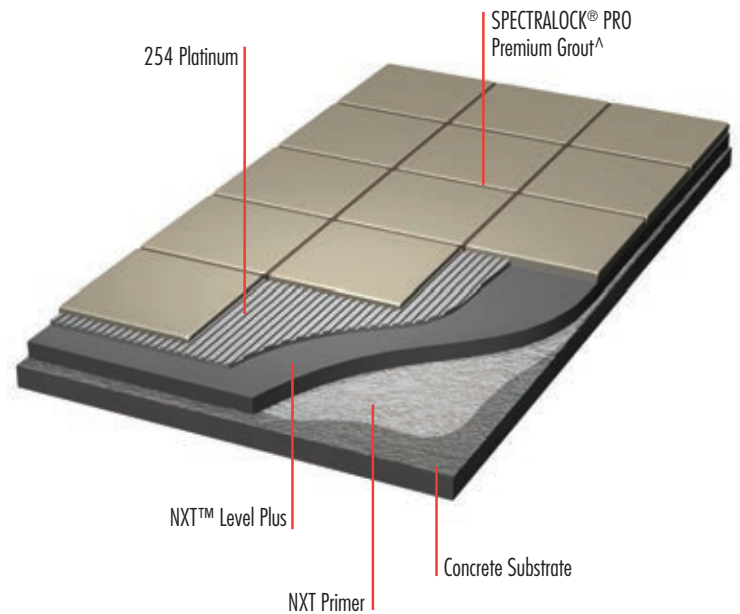

^{^^}StainProof (residential installation only) to common household cleaners, liquids and other goods. Clean all spills immediately.

[†]United States Patent No.: 6,881,768 (and other Patents).

[^]United States Patent No.: 6,784,229 B2 (and other Patents).





A complete shower installation system from the substrate up!



HYDRO BAN® Drains, Pre-Sloped Pans, Preformed Seats and Preformed Niches, are designed for use with LATICRETE installation materials to create the ultimate shower installation system. HYDRO BAN bonds directly to the HYDRO BAN Linear Drains and to the HYDRO BAN Bonding Flange Drain assembly allowing for a faster, easier and completely waterproof installation.



SYSTEM COMPONENTS:

HYDRO BAN®

- Bonds directly to metal and a variety of plastic plumbing fixtures
- Anti-fracture protection of up to 1/8" (3 mm) over shrinkage and other non-structural cracks
- Extra Heavy Service rating per ASTM C627 performance levels
- Meets ANSI A118.10 and ANSI A118.12 standards
- IAPMO and ICE approved

HYDRO BAN Pre-Sloped Shower Pans

- Available in standard and custom sizes
- Perfect pitch to the drain for proper water flow
- Made of lightweight high-density expanded polystyrene
- Available in linear (shown) or standard drain configurations
- Use in new construction or remodels
- Waterproof and ready to tile
- Code approved – IAPMO PS-46

HYDRO BAN Pre-Formed Benches, Seats, Niches and Shelves

- Lightweight high-density expanded polystyrene
- Easy to install with LATICRETE premium setting materials
- Waterproof and ready to tile

HYDRO BAN Linear Drain

- Low profile design is ideal for large format tile and stone
- Allows for placement along walls and intermediate locations
- Adjustable grate height allows for range of tile or stone thicknesses
- Available in standard and custom lengths
- Code approved per ASME A112.18-2-2005/ CSA B125.2.05

HYDRO BAN Bonding Flange Drain

- Suitable for tile thickness of 1/4" – 1 1/2" (6mm – 38mm)
- Compatible with 3701 Mortar Bed and HYDRO BAN providing a complete waterproof assembly
- Available in four drain options; tile-in grate, brushed, polished, or oil rubbed bronze stainless steel grate

LATASIL™

- 100% silicone sealant
- Available in 25 colors and clear
- Use in fully submerged or wet areas when used with LATASIL™ 9118 Primer
- Meets ASTM C794 and C920

SYSTEM APPLICATIONS:

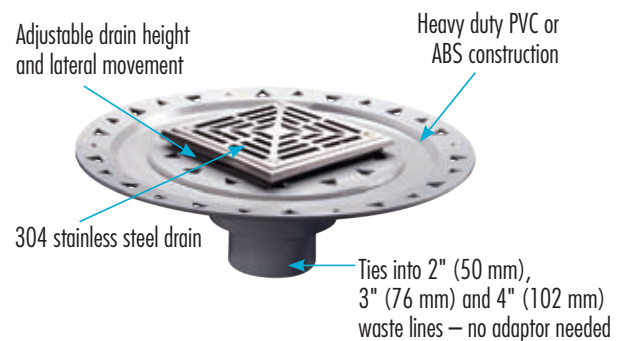
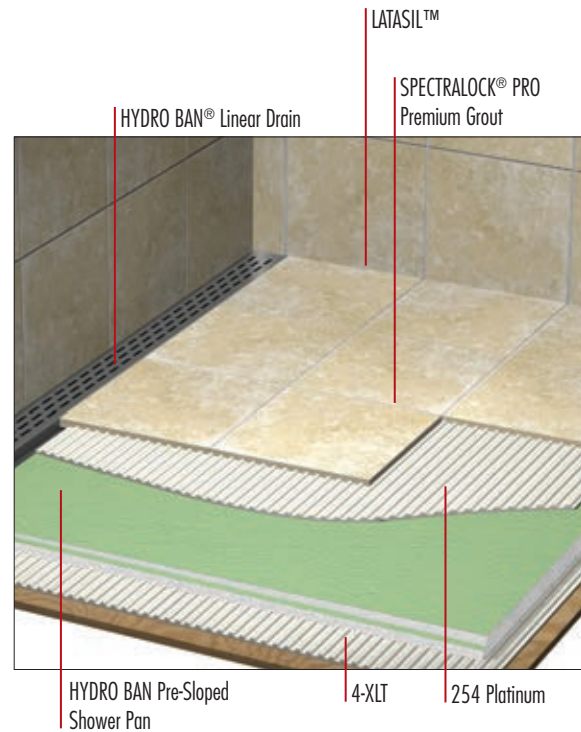

CHOOSE FROM 4 LINEAR DRAIN OPTIONS 304 stainless steel drain

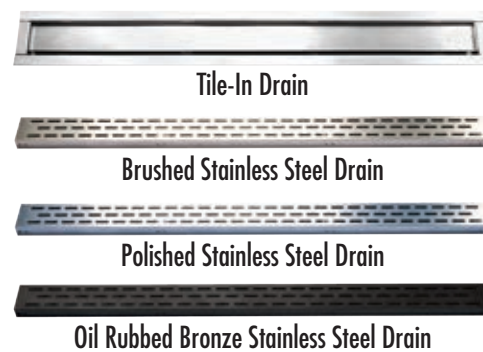



LATICRETE offers proven installation solutions for commercial and industrial floors from the substrate up.

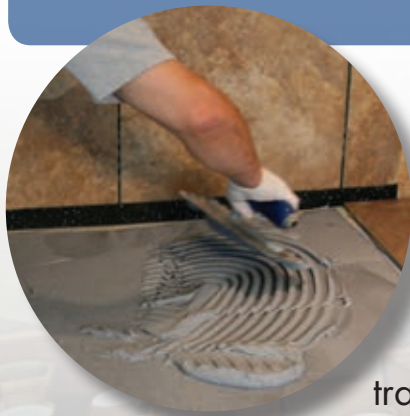

LATICRETE Commercial and Industrial Flooring Systems have been specified for over 50 years around the globe in facilities such as malls, restaurants and airports, as well as dairies, breweries, and other high demand/high traffic applications.



SYSTEM COMPONENTS:

HYDRO BAN®

- Bonds directly to metal and a variety of plastic plumbing fixtures
- Anti-fracture protection of up to 1/8" (3 mm) over shrinkage and other non-structural cracks
- Extra Heavy Service rating per ASTM C627 performance levels
- Meets ANSI A118.10 and ANSI A118.12 standards
- IAPMO and ICE approved

125 Sound & Crack Adhesive (Light Commercial only)

- Crack isolation, sound control and adhesive in one
- Provides sound control of (delta)IIC of 19
- Contains over 30% post consumer recycled materials
- Meets ANSI A118.12 anti-fracture performance
- Meets EN 12004/C1ES2 and ISO 13007-1 C1ES2

LATAPOXY® 300 Adhesive

- Superior bond strength
- Ideal for installing moisture sensitive marble and agglomerate tiles
- Non-staining on white and light-colored marble
- Maximum chemical resistance
- Meets ANSI A118.3, EN 12004/R2T, and ISO 13007-1/R2T

SPECTRALOCK® PRO Premium Grout[^]

- Available in 40 colors
- Stainproof^{^^} and chemical resistant
- Easily installs on floors and walls; never needs sealing
- Use in interior and fully submerged applications
- Exceeds ANSI A118.3

SPECTRALOCK 2000 IG

- Recommended for industrial application and commercial kitchens
- Maximum performance grout
- Available in 39 colors
- Easy to install and clean
- Chemical resistant
- Exceeds ANSI A118.3 and A118.5 requirements
- Meets ISO 13007-3/R2

^{^^}StainProof (residential installation only) to common household cleaners, liquids and other goods. Clean all spills immediately.

^{*}United States Patent No.: 6,881,768 (and other Patents).
[†]United States Patent No.: 6,784,229 B2 (and other Patents).

254 Platinum

- Suitable for interior and exterior applications.
- Exceptional bond strength and easy workability
- Microban® antimicrobial protection
- Exceeds ANSI A118.4, ANSI A118.11 and ANSI A118.15
- Meets EN 12004/C2TES1 and meets ISO 13007-1/C2TES1P1

LATASIL™

- 100% silicone sealant
- Available in 25 colors and clear
- Use in fully submerged or wet areas when used with LATASIL™ 9118 Primer
- Meets ASTM C794 and C920

SYSTEM APPLICATIONS:

Commercial Flooring

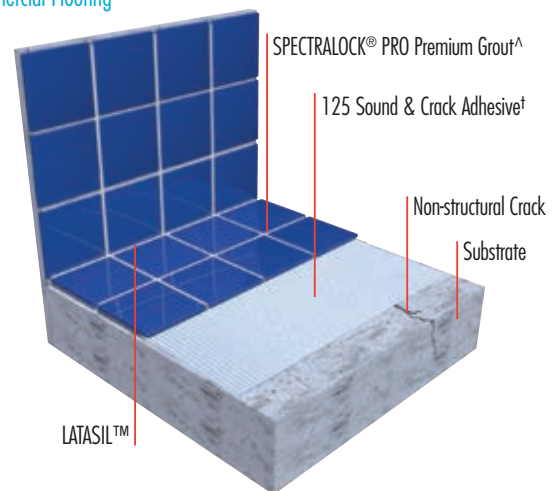

Industrial Flooring

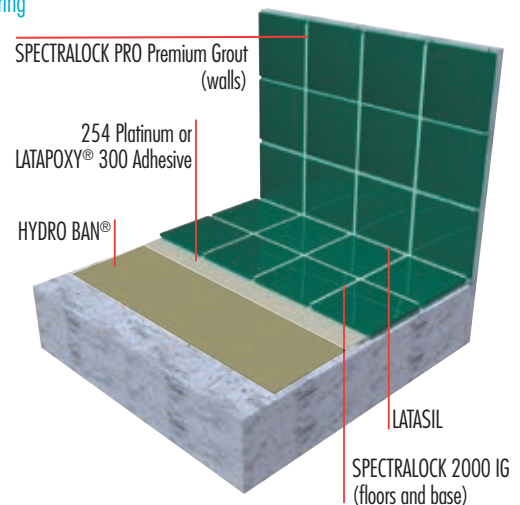



LATICRETE offers an industry leading sound protection solution backed by a 25 Year System Warranty and can help contribute to LEED points.



The LATICRETE Sound Protection System is the first choice of contractors and architects alike. A stand-alone sound control underlayment, 170 Sound & Crack Isolation Mat obtains a Δ IIC of 19 as tested per ASTM E2179 and an IIC rating of 65 per ASTM E989/492. For critical turn around times, 125 Sound & Crack Adhesive allows for maximum productivity as it provides sound control performance and anti-fracture performance while serving as the tile adhesive! No waiting or multiple steps are needed.



SYSTEM COMPONENTS:

170 Sound & Crack Isolation Mat

- Provides a Delta IIC of 20 for sound control
- Contains 89% post consumer recycled materials
- Available in additional thicknesses*
- Anti-fracture performance up to 1/8" (3mm)
- Meets ANSI A118.12 and A118.13

125 Sound & Crack Adhesive

- Crack isolation, sound control and adhesive in one
- Provides sound control of (delta)IIC of 19
- Contains over 30% post consumer recycled materials
- Meets ANSI A118.12 anti-fracture performance
- Meets EN 12004/C1ES2 and ISO 13007-1 C1ES2

254 Platinum

- Suitable for interior and exterior applications.
- Exceptional bond strength and easy workability
- Microban® antimicrobial protection
- Exceeds ANSI A118.4, ANSI A118.11 and ANSI A118.15
- Meets EN 12004/C2TES1 and meets ISO 13007-1/C2TES1P1

SPECTRALOCK® PRO Premium Grout^

- Maximum performance epoxy grout
- Available in 40 colors
- Stainproof^{FA} and chemical resistant
- Easily installs on floors and walls; never needs sealing
- Use in interior and fully submerged applications
- Exceeds ANSI A118.3

PERMACOLOR® Grout†

- High Performance cement based grout
- Inhibits the growth of stain-causing mold and mildew with Microban®
- Exceeds ANSI A118.7
- Meets EN 12888/CG2WA and Meets ISO 13007-3/CG2WA

LATASIL™

- 100% silicone sealant
- Available in 25 colors and clear
- Use in fully submerged or wet areas when used with LATASIL™ 9118 Primer
- Meets ASTM C794 and C920

SYSTEM APPLICATIONS:

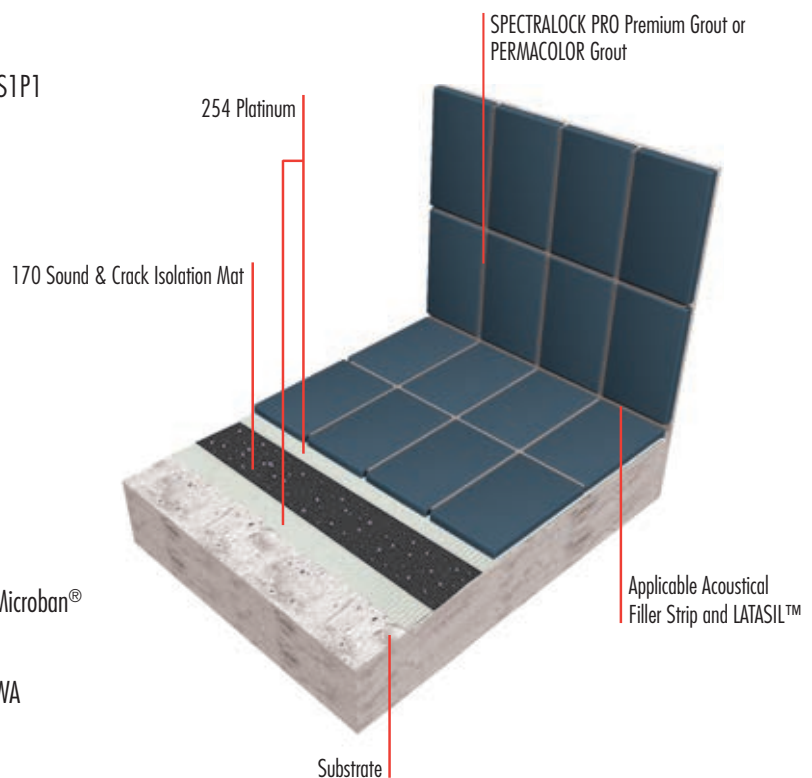
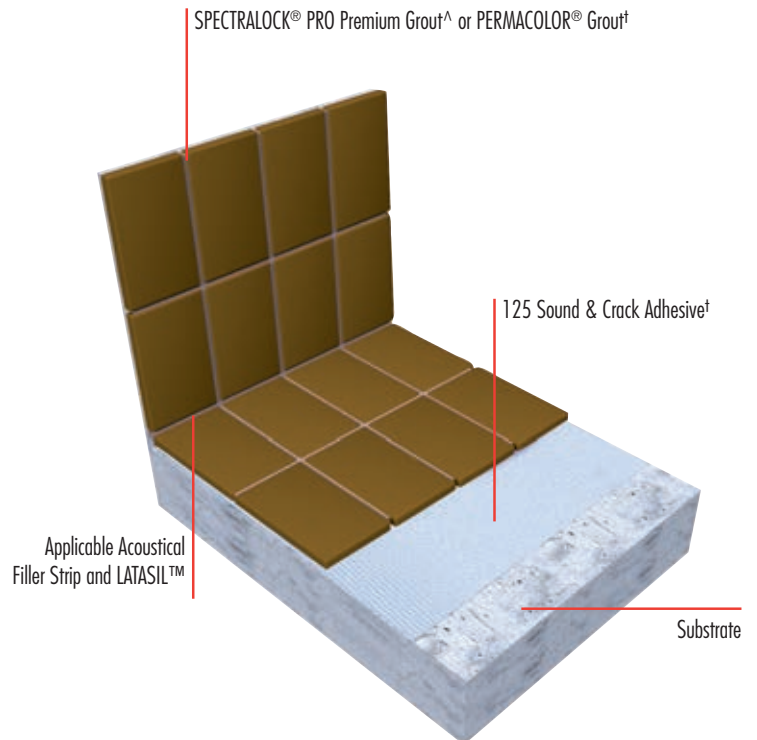

STRATA_MAT™ is part of the LATICRETE Lifetime System Warranty – providing one source, one warranty from the substrate to the grout.



STRATA_MAT™ is a high performance uncoupling mat for use under ceramic tile and stone installations, for both residential and commercial applications. Specifically designed for use with either polymer modified or unmodified mortars, STRATA_MAT allows for the proper adhesive mortar to be used with the appropriate tile or stone per industry standards.



SYSTEM COMPONENTS:

STRATA_MAT™

- For use under ceramic tile and stone installations, for both residential and commercial applications
- Designed to replace traditional underlayment materials; unique patent pending design provides for an enhanced mechanical bond of the adhesive mortar and provides for faster drying of the mortar
- Specifically designed for use with both modified and unmodified mortars
- Provides vapor management
- Eliminates transmission of in plane substrate cracks of up to 1/8" (3 mm)
- Meets ANSI A118.12
- Rated Extra Heavy per TCNA as tested using ASTM C627

254 Platinum

- Suitable for interior and exterior applications.
- Exceptional bond strength and easy workability
- Microban® antimicrobial protection
- Exceeds ANSI A118.4, ANSI A118.11 and ANSI A118.15
- Meets EN 12004/C2TES1 and meets ISO 13007-1/C2TES1P1

SPECTRALOCK® PRO Premium Grout^

- Maximum performance epoxy grout
- Available in 40 colors
- Stainproof^{AA} and chemical resistant
- Easily installs on floors and walls; never needs sealing
- Use in interior and fully submerged applications
- Exceeds ANSI A118.3

PERMACOLOR® Grout†

- High Performance cement based grout
- Inhibits the growth of stain-causing mold and mildew with Microban®
- Exceeds ANSI A118.7
- Meets EN 12888/CG2WA and meets ISO 13007-3/CG2WA

SYSTEM APPLICATIONS:

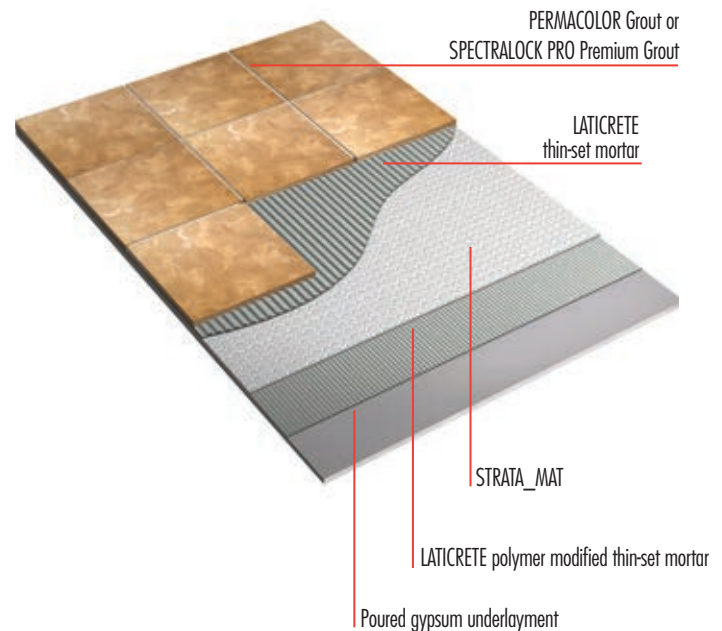
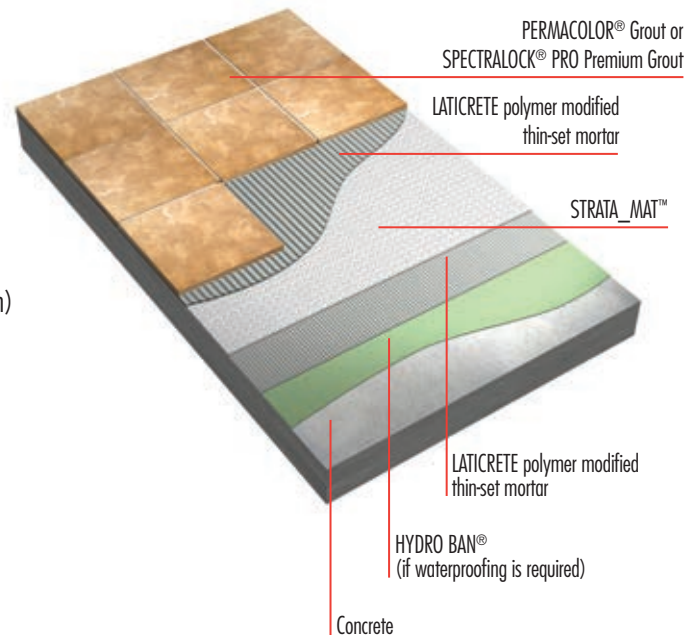

^{AA}StainProof (residential installation only) to common household cleaners, liquids and other goods. Clean all spills immediately.

[†]United States Patent No.: 6,881,768 (and other Patents).

[^]United States Patent No.: 6,784,229 B2 (and other Patents).



Vertical installations of ceramic tile or stone require expertise, high performance products and a proven track record of success.



Our Exterior Facade System is the benchmark of the industry. For those interior or exterior applications requiring maximum installation speed and strength, LATAPOXY® 310 Stone Adhesive is a high strength epoxy adhesive that is building code approved with over 15 years of global installations. 254 Platinum and our non-sag

255 MULITMAX™†, are equipped with Microban and are UL GREENGUARD Gold certified for low VOC.



SYSTEM COMPONENTS:

HYDRO BAN®

- Bonds directly to metal and a variety of plastic plumbing fixtures
- Anti-fracture protection of up to 1/8" (3 mm) over shrinkage and other non-structural cracks
- Extra Heavy Service rating per ASTM C627 performance levels
- Meets ANSI A118.10 and ANSI A118.12 standards
- IAPMO and ICE approved

254 Platinum

- Suitable for interior and exterior applications.
- Exceptional bond strength and easy workability
- Microban® antimicrobial protection
- Exceeds ANSI A118.4, ANSI A118.11 and ANSI A118.15
- Meets EN 12004/C2TES1 and meets ISO 13007-1/C2TES1P1

255 MULTIMAX™†

- Versatile lightweight mortar
- Build up to 3/4" (19 mm) without shrinkage, slump, sag or slippage
- Reinforced with Kevlar®^
- Inhibits the growth of stain-causing mold and mildew with Microban®
- Meets ISO 13007-1 C2TP1

LATAPOXY® 310 Stone Adhesive

- Fast permanent bond
- Withstands shock and vibration
- Approved for exterior installations by building codes: ICC, IBC
- Meets ANSI A118.3, meets EN 12004/R2T and meets ISO 13007-1/R2T

PERMACOLOR® Grout†

- High Performance cement based grout
- Inhibits the growth of stain-causing mold and mildew with Microban®
- Exceeds ANSI A118.7
- Meets EN 12888/CG2WA and Meets ISO 13007-3/CG2WA

LATASIL™

- 100% silicone sealant
- Available in 25 colors and clear
- Use in fully submerged or wet areas when used with LATASIL™ 9118 Primer
- Meets ASTM C794 and C920

SYSTEM APPLICATIONS:

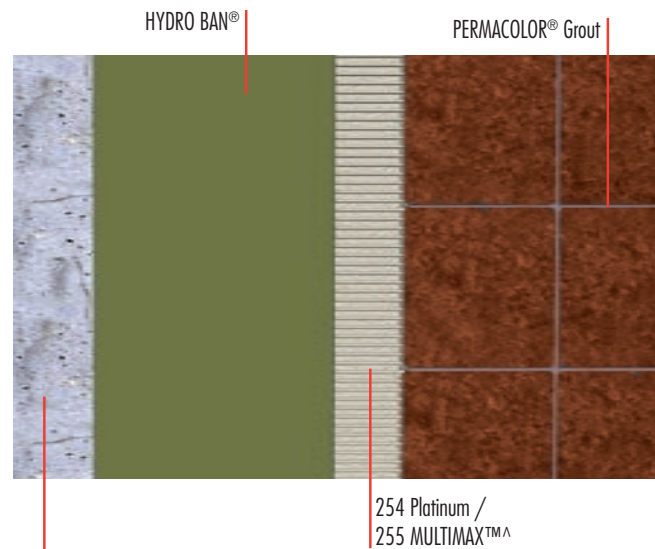

Properly Prepared Concrete, Backer Board or Masonry Substrates
(if substrate requires leveling, use 3701 Fortified Mortar Bed)

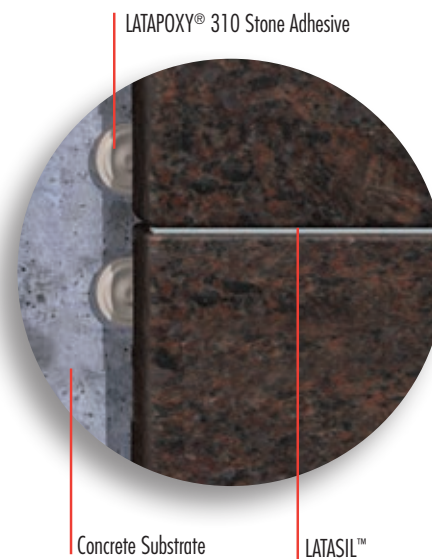

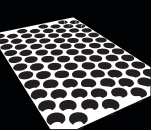

PLAZA AND DECK SYSTEM

LATICRETE offers a proven installation solution for plaza and deck system terraces, patios, courtyards and decks.



The LATICRETE Plaza and Deck System is designed for exterior use over occupied space and wood construction decks. The patented, lightweight Tile Drain Mat provides three times the drainage rate of a conventional crushed gravel bed and is engineered to permit maximum load transfer to the structural deck while allowing lateral flow of infiltrated water. This unique system is recommended for new construction and renovation such as plazas, walkways, exposed decks, balconies, terraces, courtyards, and any exterior paving area subject to severe weather, frost and moisture.



SYSTEM COMPONENTS:

Tile Drain Mat

- Provides 3x the drainage rate of a conventional 2" (50 mm) crushed gravel bed
- Provides integral subsurface drainage for infiltrated water and reduces the potential for efflorescence
- Extra heavy rating for system per ASTM C627

3701 Fortified Mortar Bed

- Polymer fortified – no need for latex additives
- Economical – saves time and money
- High strength formula
- Exceeds ASTM C270 requirements

HYDRO BAN®

- Bonds directly to metal and a variety of plastic plumbing fixtures
- Anti-fracture protection of up to 1/8" (3 mm) over shrinkage and other non-structural cracks
- Extra Heavy Service rating per ASTM C627 performance levels
- Meets ANSI A118.10 and ANSI A118.12 standards
- IAPMO and ICE approved

254 Platinum

- Suitable for interior and exterior applications.
- Exceptional bond strength and easy workability
- Microban® antimicrobial protection
- Exceeds ANSI A118.4, ANSI A118.11 and ANSI A118.15
- Meets EN 12004/C2TES1 and meets ISO 13007-1/C2TES1P1

PERMACOLOR® Grout†

- High Performance cement based grout
- Inhibits the growth of stain-causing mold and mildew with Microban®
- Exceeds ANSI A118.7
- Meets EN 12888/CG2WA and Meets ISO 13007-3/CG2WA

LATASIL™

- 100% silicone sealant
- Available in 25 colors and clear
- Use in fully submerged or wet areas when used with LATASIL™ 9118 Primer
- Meets ASTM C794 and C920

SYSTEM APPLICATION:

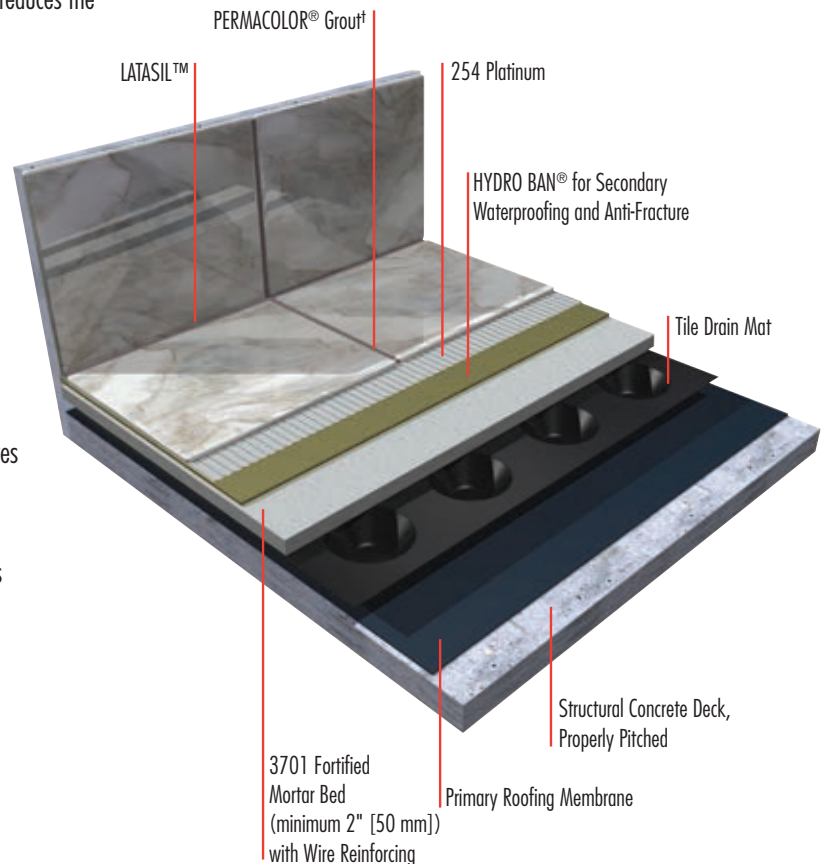

LATICRETE provides the solution for adhered masonry veneers by offering a comprehensive quality controlled installation system.

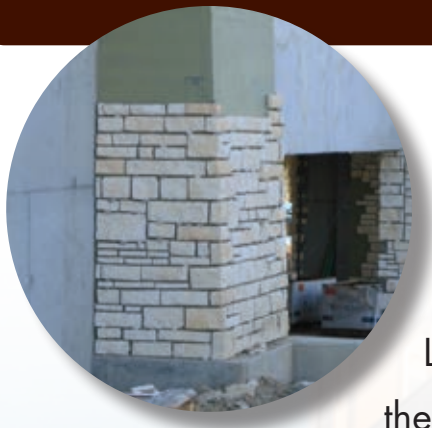

The increase in popularity of adhered masonry veneer facades has left the industry absent of suitable installation materials and detailed specifications — LATICRETE has the answer! Utilizing proven materials, the Masonry Veneer Installation System (MVIS™) proven technology will provide a permanent, high strength installation that is freeze/thaw stable and helps protect from water intrusion.

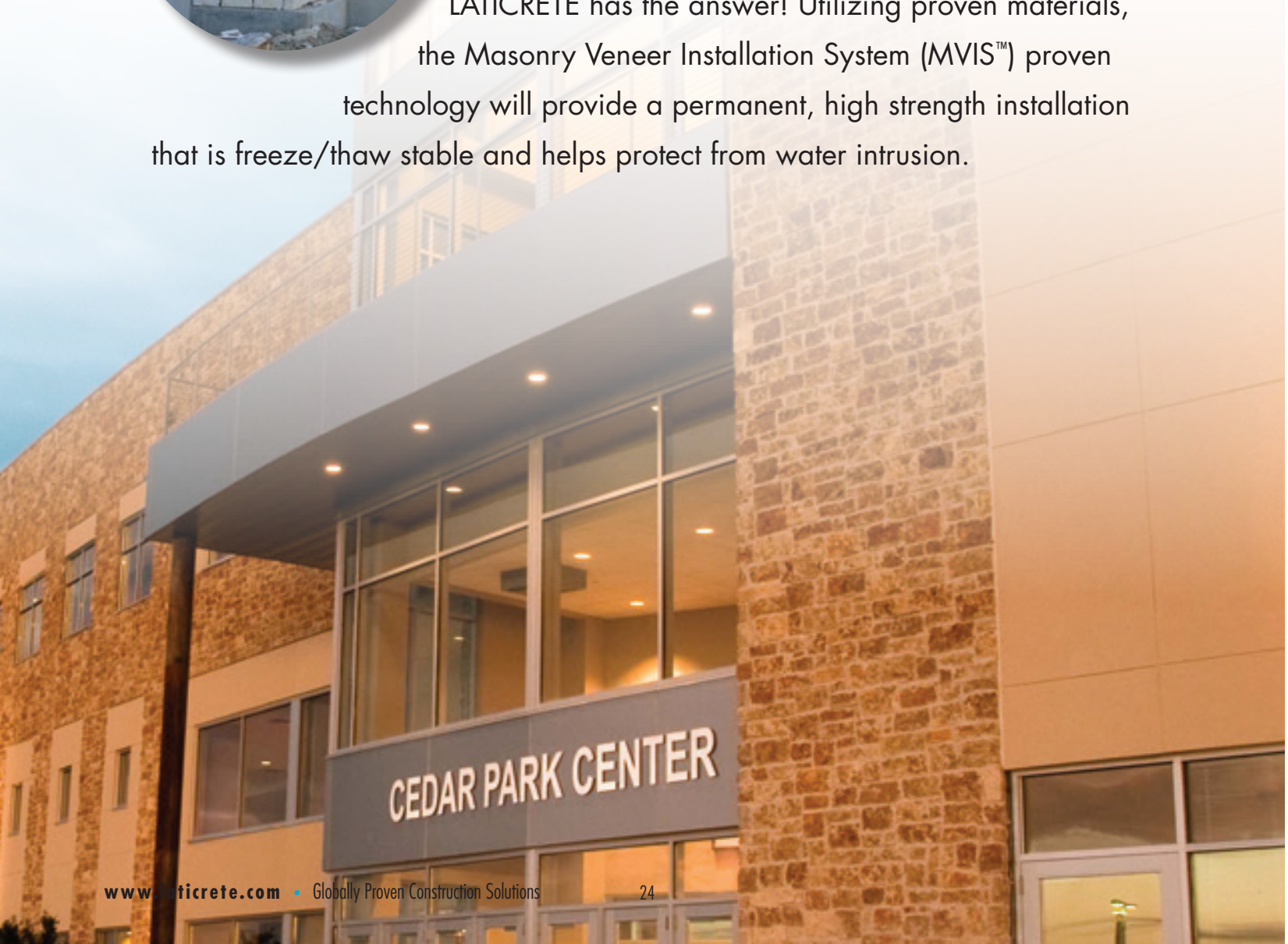

SYSTEM COMPONENTS:

Air & Water Barrier

- Single component, load bearing, vapor permeable, fluid applied membrane
- Designed for use as a waterproofing, crack isolation, and air barrier behind most exterior wall claddings
- Excellent bond strength to a wide variety of substrates
- May contribute to overall building energy efficiency
- Exceeds ICC-ES AC 212

Hi-Bond Masonry Veneer Mortar

- Polymer-fortified adhesive mortar
- For interior and exterior installation of adhered masonry veneer, natural stone, and thin brick
- Excellent bond strength, reinforced with Kevlar

Premium Masonry Pointing Mortar

- Ideal for floors and walls (joint widths 1/4" – 1/2" [6.35mm – 127mm])
- Provides a joint that is dense, hard and durable
- Available in 9 colors

Silicone Sealant

- 100% silicone sealant for use in coves, corners, changes in plane and expansion joints in exterior and interior applications
- Use in fountains, water features and other wet area applications
- Meets ASTM C920 and C794
- Available in selected colors and clear

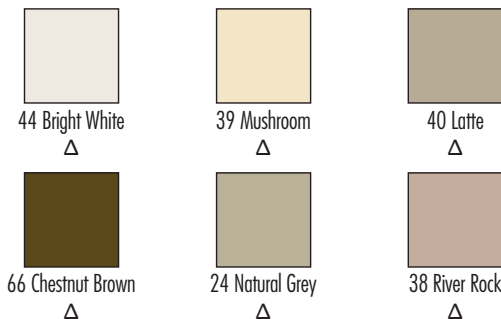

△ Silicone Sealant available in clear and colors indicated.

SYSTEM APPLICATIONS:

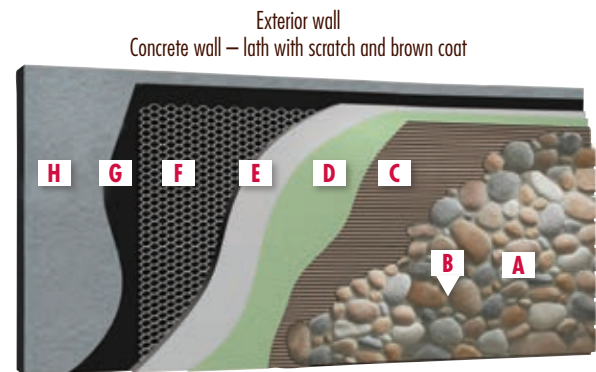
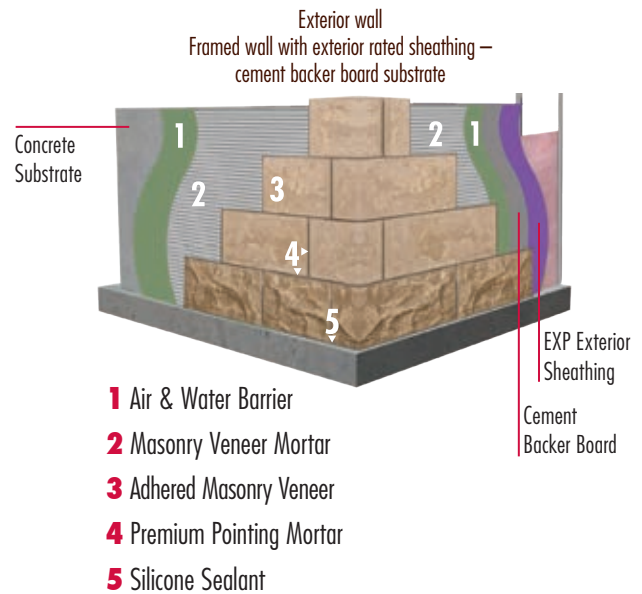

- A Adhered Masonry Veneer
- B Premium Masonry Pointing Mortar
- C Masonry Veneer Mortar
- D Air & Water Barrier
- E Premium Mortar Bed
- F Metal Lath, 3.4# galvanized diamond wire lath
- G Vapor retarder/cleavage membrane type and location per design professional (e.g. 15 lb builders felt or 4 mil polyethylene sheeting)
- H Concrete or masonry



No Longer Just a Joint Filler

LATICRETE offers innovative, technologically-advanced grout for all types of installations when frost, intense heat, thermal shock, chemical or stain resistance performance is required. Your options are globally proven components of the LATICRETE® 25 Year System Warranty*, the strongest warranty in the industry. LATICRETE grouts outperform the competition in durability, stain resistance, ease of use, and color options.

Breakthrough technology has allowed LATICRETE to develop a grout that has all the performance capabilities you require with the design freedom to augment the most spectacular creations. **SPECTRALOCK® PRO Premium Grout**[^] meets ANSI A118.3, is ready for traffic in as little as 12 hours and can be used on interior and exterior floors, walls, pools, and spas. In addition to featuring 40 lifestyle colors, SPECTRALOCK PRO Premium Grout provides an optional SPECTRALOCK DAZZLE™ component that makes ordinary grout colors metallic, pearlescent and glow-in-the-dark; with up to 220 color options!

When a project does not require the maximum stain resistance or performance of SPECTRALOCK PRO Premium Grout but requires increased performance over standard grout, **PERMACOLOR® Grout** is the solution. Equipped with Microban® and certified low VOC by UL Environmental, PERMACOLOR Grout offers a vibrant consistent color and is suitable for narrow or wide joints.

When maximum chemical, stain, and high temperature resistance is required, **SPECTRALOCK 2000 IG** is recommended. SPECTRALOCK 2000 IG is a 100% solids epoxy grout which exceeds the performance requirements of ANSI A118.3, ANSI A118.5, and ISO 13007-3 R2. Unaffected by most acids, corrosives, and solvents, SPECTRALOCK 2000 IG is ready for traffic in as little as 12 hours and can be used on floors in meat and poultry plants, dairies, breweries, clean-in-place rooms, animal clinics, and commercial kitchens.

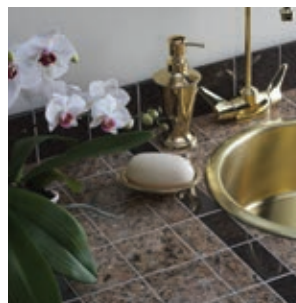
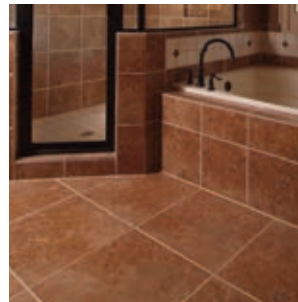

LATICRETE® and LATAPOXY® Grouts and Sealants

This chart shows available colors for the following grouts and sealants:





SPECTRALOCK® PRO Premium Grout†
 SPECTRALOCK PRO Grout†
 PERMACOLOR® Grout^
 1500 Sanded Grout
 1600 Unsanded Grout
 SPECTRALOCK 2000 IG
 LATASIL™
 Premium Acrylic Caulk

Grout and Sealant Selection Key

AVAILABLE IN ALL 40 COLORS:

SPECTRALOCK® PRO Premium Grout†
 SPECTRALOCK PRO Grout†
 PERMACOLOR® Grout^
 Premium Acrylic Caulk (Sanded and Unsanded)
 I, II and III Pricing Group

AVAILABLE IN SELECTED COLORS:

-  LATASIL™
-  SPECTRALOCK DAZZLE™ Glow
-  1500 Sanded Grout (25lb bags and 10lb cartons) and 1600 Unsanded Grout (8lb cartons only)
-  1600 Unsanded Grout colors available in 25 lb (11.3 kg) bags
-  SPECTRALOCK 2000 IG is not for use with 44 Bright White

SPECTRALOCK® PRO Premium Grout†, SPECTRALOCK PRO Grout, PERMACOLOR® Grout^, and Premium Acrylic Caulk are available in all 40 colors. Use Grout Selection Key for all other products. SPECTRALOCK DAZZLE™ (Gold, Silver, Copper and Mother-of-Pearl) can be mixed with all 40 colors of SPECTRALOCK PRO Premium Grout or SPECTRALOCK PRO Grout.

 44 Bright White I     	 18 Sauterne III   	 16 Siltstone II 	 85 Almond II    	 03 Silk III  
 23 Antique White II    	 39 Mushroom II   	 41 Kashmir II  	 81 Butter Cream II  	 52 Toasted Almond II   
 55 Tawny II 	 17 Marble Beige III    	 40 Latte II   	 61 Parchment II    	 30 Sand Beige I  
 56 Desert Khaki II  	 38 River Rock II 	 27 Hemp III  	 57 Hot Cocoa II 	 92 Saltillo III  
 58 Terra Cotta II 	 46 Quarry Red I 	 43 Chocolate Truffle III  	 66 Chestnut Brown III  	 59 Espresso II 
 35 Mocha I  	 50 Sea Glass II   	 67 Autumn Green II 	 53 Twilight Blue III	 42 Platinum I  
 91 Slate Grey II 	 88 Silver Shadow I    	 89 Smoke Grey III   	 90 Light Pewter II  	 78 Sterling Silver II   
 24 Natural Grey I  	 34 Sandstone II 	 60 Dusty Grey II 	 45 Raven II 	 22 Midnight Black I  

NOTE: Grout color availability subject to change. Visit www.laticrete.com for the most current color selections.

† United States Patent No.: 6881768 and other Patents.
 ^ United States Patent No.: 6784229 and other Patents.



**Globally Proven
Construction Solutions**

Corporate Headquarters:

LATICRETE International, Inc.
One LATICRETE Park North
Bethany, CT 06524-3423 USA
1.800.243.4788
+1.203.393.0010

www.laticrete.com

Africa: +27.078.343.4029

Asia Pacific: +86.21.5789.3300

Australia: +61.7.3865.1599

China: +86.21.5789.3300

Europe: +44.871.284.5959

India: +91.40.3041.3100

Latin America: +1.203.393.0010

Middle East: +971.7.244.6396

Mexico: +44.151.486.6101

South East Asia: +65.6515.3028

UK: +44.151.486.6101

TECHNICAL ASSISTANCE

USA/CANADA: 1.800.243.4788, ext. 235

Worldwide: +1.203.393.0010, ext 235

Fax: +1.203.393.1948

Email: technicalservices@laticrete.com